

WEST SYSTEM®

epoxy



Over Forty Years of Epoxy Technology and Innovation



User Manual and Product Catalogue



Contents

USER MANUAL	1. User Manual Introduction	1
	2. Handling Epoxy	3
	2.1 Epoxy Safety	3
	2.2 Clean Up	4
	2.3 Epoxy Chemistry	4
	2.4 Dispensing and Mixing	7
	2.5 Adding Fillers and Additives	8
	3. Basic Techniques	10
	3.1 Surface Preparation	10
	3.2 Bonding (Gluing)	13
	3.3 Bonding with Fillets	15
	3.4 Bonding Fasteners and Hardware	16
	3.5 Laminating	20
	3.6 Fairing	21
	3.7 Applying Woven Cloth and Tape	22
	3.8 Epoxy Barrier Coating	26
	3.9 Barrier Coating for Osmosis Repair	27
	3.10 Final Surface Preparation	28
	3.11 Finish Coatings	29
	4. Cold Temperature Bonding	31
	4.1 Chemical Characteristics	31
	4.2 Working Properties	31
	4.3 Cold Weather Techniques	32
	4.4 Cold Weather Storage	33
	5. Product Selection and Estimating Guides	34
	6. Problem Solver	36
	7. The Products	39
PRODUCT GUIDE	8. Product Guide	40
	8.1 WEST SYSTEM Resins and Hardeners	40
	8.2 Epoxy Dispensers	42
	8.3 Repair Packs and Resin Packs	44
	8.4 Specialty Epoxies	44
	8.5 WEST SYSTEM Packs	46
	8.6 Fillers	46
	8.7 Additives	48
	8.8 Reinforcing Materials	49
	8.9 Application Tools	51
	8.10 Instructional Publications	54
	8.11 Instructional Videos	56
	8.12 Instructional DVD	56

1. USER MANUAL INTRODUCTION

WEST SYSTEM epoxy is a versatile, high-quality, two-part epoxy that is easily modified for a wide range of coating and adhesive applications. It is used for construction and repairs requiring superior moisture resistance and high strength. Originally developed by Gougeon Brothers Inc. over 40 years ago for the production of wooden boats, WEST SYSTEM epoxy products are now recognised throughout the marine industry and are in everyday use for the repair and construction of fibreglass, wood, aluminium, steel, composite and ferrocement vessels. The knowledge that the WEST SYSTEM epoxy is designed for the marine environment - a particularly harsh and demanding requirement - promotes enormous confidence in the product range and, in more recent years, WEST SYSTEM epoxy has been used extensively in the construction industry, model making and the DIY market for many applications.

(See Our Booklet – “Other Uses-Suggestions for Household Repair”).

This Manual is designed to help you become familiar with WEST SYSTEM products and to use them effectively. It also provides information about safety, handling and the basic techniques of epoxy use which will allow the WEST SYSTEM products to be tailored to your exact repair and construction needs. These techniques are used in a wide range of repair and building procedures such as those described in detail in WEST SYSTEM instructional publications and DVD.

The Problem Solver will help you identify and prevent potential problems associated with using epoxy.

The Product Guide gives a complete description of the WEST SYSTEM products, including selection and coverage guides, to assist in choosing the most appropriate products and package sizes for the job in hand.

WEST SYSTEM products are available from quality marine chandleries throughout the world. For the name of your nearest chandlery or for additional technical, product, or safety information, contact Wessex Resins and Adhesives or your local distributor.

Why WEST SYSTEM epoxy?

All epoxies are different. Epoxy brands vary considerably in their formulations, quality of raw materials and their suitability for marine and other extreme environments. It is not difficult to market a general purpose epoxy for the marine industry or to formulate a product having some favourable characteristics whilst sacrificing other important physical properties. However, it is much more difficult balancing all the physical

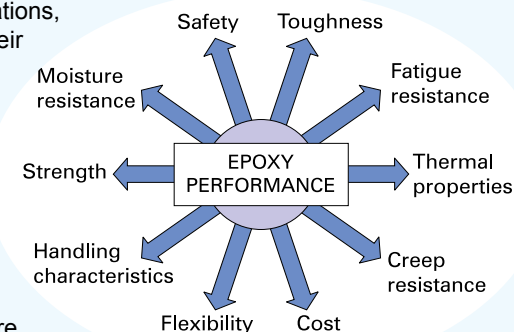

and mechanical properties necessary for a versatile, high quality marine epoxy. Defining the required performance criteria and designing a formula to meet those criteria requires good chemistry, rigorous test programmes, extensive field trials, continuing contact with the industry and direct experience with today's high-performance boat builders and other composite users.

Balanced epoxy performance

WEST SYSTEM epoxy is designed for boatbuilding and repair by experienced epoxy formulators who know the engineering and the chemistry required for today's high-performance composite structures. With more than forty years of developing marine epoxies, Gougeon Brothers Inc. and Wessex Resins & Adhesives Ltd. have continued to formulate, test and improve WEST SYSTEM resin and hardeners to create the most reliable and well balanced epoxy system available today.

Potential resin and hardener formulae, ingredients and combinations are tested to compare fatigue strength, compression strength, glass transition temperature and peak exotherm. Additionally, samples are tested for hardness, tensile strength, tensile elongation, tensile modulus, flexural strength, flexural modulus, heat deflection temperature, impact resistance and moisture exclusion effectiveness. Such thorough testing ensures that any change in a formulation will improve at least one characteristic of the product without diminishing the other properties.

Comprehensive testing

Continuing research and comprehensive testing are essential for the development of both improved epoxy formulations and better construction and repair methods. In addition, the material test laboratory also conducts extensive test programmes to support builders, designers and industry on specific projects.

Standard BS EN ISO Test Procedures are normally used to evaluate the physical properties of adhesives and composite laminates but, occasionally, the laboratory is called upon to evaluate to a particular DIN or ASTM Standard.

The information provided by a comprehensive test programme and feedback from customers contributes to a data base on epoxies and epoxy composites that is continuously growing. This knowledge is invaluable for achieving the proper balance of properties required for a versatile, high-quality marine epoxy and ensures the information is up-to-date and reliable.

Technical support

To ensure that the ultimate characteristics and versatility of the WEST SYSTEM epoxy are achieved, Wessex Resins provides one other important ingredient – technical service. Whether the project in hand is large or small, WEST SYSTEM technical publications and videos offered in this guide provide detailed procedures and instructions for specific repair and construction applications. Further assistance can be obtained by writing or contacting our technical staff either via Telephone: **+44 (0) 1794 521111** or by email: techinfo@wessex-resins.com – we are always interested in your projects whether it is a major repair on a boat, replacing a rotting window sill at home or a simple DIY job in the garage.

2. HANDLING EPOXY

This section explains the fundamentals of epoxy safety, curing and the steps for proper dispensing, mixing and adding fillers to ensure that every batch cures to a high strength solid.

2.1 Epoxy Safety

Epoxies are safe when handled properly but it is essential to understand the hazards and take precautions to avoid them.

Hazards

The primary hazard associated with epoxy involves skin contact. WEST SYSTEM Resin may cause moderate skin irritation; WEST SYSTEM Hardeners may cause severe skin irritation. Resins and hardeners are also sensitizers and may cause an allergic reaction but, from our experience, most people are not sensitive to WEST SYSTEM Resin and Hardeners. These hazards decrease as resin/hardener mixes reach full cure but it is important to appreciate that the hazards also apply to the sanding dust from partially cured epoxy. Please refer to the Material Safety Data Sheets (MSDS) for specific product warnings and safety information.

Precautions

1. Avoid contact with resin, hardeners, mixed epoxy and sanding dust. Wear protective gloves and clothing when handling WEST SYSTEM materials. WEST SYSTEM 831 Barrier Cream provides additional protection for sensitive skin and allergies. **DO NOT** use solvents to remove epoxy from the skin. Immediately after skin contact with resin, hardeners, sanding dust from epoxy and/or solvents, use WEST SYSTEM 820 Resin Removing Cream for the initial clean-up, followed by a wash with soap and warm water.

If a skin rash develops while working with epoxy, stop using the product until the rash completely disappears. If problems persist when work is resumed, discontinue use and consult a doctor.

2. Protect your eyes from contact with resin, hardeners, mixed epoxy, and sanding dust by wearing appropriate eye protection. If contact occurs, immediately flush the eyes with water for 15 minutes. If discomfort persists, seek medical attention.

3. Avoid breathing concentrated vapours and sanding dust. WEST SYSTEM epoxy vapours can build up in unvented spaces and ample ventilation must be provided when working with epoxy in confined areas such as boat interiors. When adequate ventilation is not possible, wear an approved respirator.

4. Avoid ingestion. Wash thoroughly after handling epoxy, especially before eating. If epoxy is swallowed, drink large quantities of water - **DO NOT** induce vomiting. Call a doctor immediately. Refer to First Aid procedures on the Material Safety Data Sheet.

5. KEEP RESINS, HARDENERS, FILLERS AND SOLVENTS OUT OF THE REACH OF CHILDREN.

For additional safety information or data, write to: EPOXY SAFETY, Wessex Resins & Adhesives, Cupernham House, Cupernham Lane, Romsey, Hampshire SO51 7LF

2.2 Clean Up

Contain spills with sand, clay or other inert absorbent materials and use a scraper to collect as much material as possible. Follow up with absorbent towels.

DO NOT use either sawdust or other fine cellulose materials to absorb hardeners and/or dispose of hardener in waste containing sawdust or other fine cellulose materials—spontaneous combustion may occur.

Clean resin, or mixed epoxy residue or uncured epoxy with WEST SYSTEM 850 Cleaning Solvent. Clean hardener residue with warm soapy water.

Dispose of resin, hardener and empty containers safely in accord with local disposal regulations.

DO NOT dispose of resin or hardener in a liquid state. Waste resin and hardener should be mixed and cured (in small quantities) to a non-hazardous inert solid.



CAUTION! Large volumes of curing epoxy can become hot enough to ignite surrounding combustible materials and produce hazardous fumes. Place containers of mixed epoxy in a safe and ventilated area away from workers and combustible materials. Dispose of the solid mass when the cure is complete and the mass has cooled. Comply with the local disposal regulations

2.3 Epoxy Chemistry

Understanding cure time

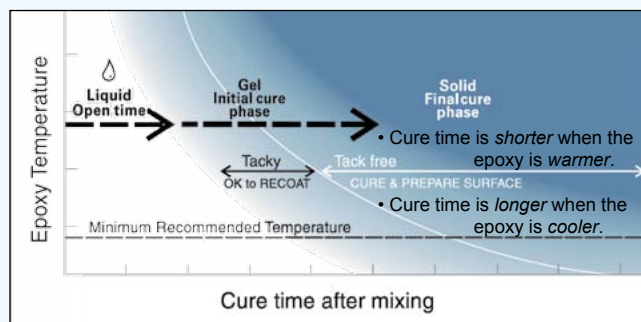

Figure 1 As it cures, mixed epoxy passes from a liquid state, through a gel state, to a solid state.

Open time and cure time determine the build and repair operations. Open time dictates the time available for mixing, application, smoothing, shaping, assembly and clamping. Cure time dictates the time before removing clamps, abrading or proceeding to the next step in the project. Three factors determine the open time and cure time of an epoxy mix – *hardener cure speed, epoxy temperature and volume of mix.*

a) Hardener speed

Each hardener has an ideal temperature cure range. At any given temperature each resin/hardener combination will go through the same cure stages but at different rates. Select the hardener that gives adequate working time for the job in hand at the temperature and conditions under which the work is to be completed. The Product Guide describes hardener pot lives and cure times.

Pot life is a term used to compare the cure speeds of different hardeners. It is the period of time a specific mass of mixed resin and hardener remains a liquid at a particular temperature e.g. a 100g mass of an epoxy mix in a standard container at 25°C is a routine quality control test procedure.

Because pot life is a measure of the speed of cure of a specific mass (volume) of epoxy rather than a thin film, the pot life of a resin/hardener mix is much shorter than its open time.

b) Epoxy temperature

The warmer the temperature the faster an epoxy mix will cure (*Figure 1*). The temperature at which epoxy cures is determined by the **ambient temperature** plus the **exothermic heat** generated by the reaction.

Ambient temperature is the temperature of the air and/or the material in contact with the epoxy. Epoxy cures faster when the ambient temperature is warmer.

c) The volume of mixed epoxy

Mixing resin and hardener together creates an exothermic (heat producing) reaction. Always mix small batches of epoxy because the greater the quantity, the more heat generated, the shorter the pot life and cure time. In a larger volume, more heat is retained, causing a faster reaction and yet more heat e.g. a plastic mixing cup containing, say, a 200g mix. can generate enough heat to melt the cup. However, if the same quantity is spread into a thin layer, the exothermic heat is not produced as quickly and the cure time of the epoxy is determined by the ambient temperature.

Controlling cure time

In warm conditions use a slower hardener to increase the open time. Mix smaller batches that can be used quickly or pour the epoxy mix into a container with greater surface area e.g. a roller pan, thereby spreading out the epoxy into a thin film and extending the open time. After thorough mixing, the sooner the epoxy is transferred or applied, the more open time is available for coating, lay-up or assembly.

In cool conditions use a faster hardener and employ a hot air gun, a heat lamp

or other dry heat source to warm the resin and hardener before mixing and/or after the epoxy is applied. At room temperature, additional heat is useful when a quicker cure is desired. **NOTE!** Unvented kerosene or propane heaters can inhibit the cure of epoxy and contaminate epoxy surfaces with unburned hydrocarbons.



CAUTION! Warming a resin/hardener mix will lower its viscosity, allowing the epoxy to run or sag more easily on vertical surfaces. In addition, heating epoxy applied to a porous substrate (soft wood or low density core material) may cause the substrate to “out-gas” and form bubbles in the epoxy coating. To avoid out-gassing, wait until the epoxy coating has gelled before warming it. Never heat mixed epoxy in a liquid state over 50°C.

Regardless of the steps taken to control the cure time, thorough planning of the application and assembly will allow maximum use of the open time and cure time of the epoxy mix.

Cure stages of epoxy

Mixing epoxy resin and hardener begins a chemical reaction that transforms the combined liquid components into a solid. As it cures, the epoxy passes from the liquid state, through a gel stage before it reaches a solid state. (Figure 1)

1. Liquid – Open time

Open time (also working time) is the period, after mixing, that the resin/hardener mix remains a liquid and is workable and suitable for application. All assembly and clamping should take place during this period to ensure a dependable bond is achieved.

2. Gel – Initial cure phase

The mix passes into an initial cure phase (also known as the “Green Stage”) when it begins to gel. The epoxy is no longer workable and will progress from a tacky gel consistency to the firmness of hard rubber. An indent can be made with the thumb nail and it is too soft to dry sand.

While the epoxy is tacky, a new application of epoxy will chemically link with it, so the surface may be bonded or recoated **without sanding**. This ability diminishes as the mix approaches the final cure phase.

3. Solid – Final cure phase

The epoxy mix has cured to a solid state and can be dry sanded and shaped. It is no longer possible to indent the surface with the thumb nail. At this stage, the epoxy has reached 90% of its ultimate strength, so clamps can be removed. The mix will continue to cure over the next few days at room temperature.

A new application of epoxy will no longer chemically link to it, so the surface must be **thoroughly washed and sanded** before recoating to achieve a good mechanical, secondary bond. See *Surface Preparation – page 10*.

Post curing

You can improve epoxy’s thermal performance and reduce the potential for fabric “print-through” by applying modest heat to the epoxy after it has cured to a solid state. Contact Wessex Resins for more information about post curing epoxy.

2.4 Dispensing and Mixing

Careful measuring of resin and hardener and thorough mixing of the two components are essential for a proper cure. Whether the resin/hardener mix is applied as a coating or modified with fillers or additives, observing the following procedures will ensure a controlled and thorough chemical transition to a high strength epoxy solid.

Dispensing

Dispense the correct proportions of resin and hardener into a clean plastic, metal or wax-free paper container (Figure 2). Do not use glass or foam containers because of the potential hazard from exothermic heat build-up. DO NOT attempt to adjust the cure time by altering the mix ratio. An accurate ratio is essential for a proper cure and full development of physical properties.



Figure 2 Dispense the correct proportions of resin and hardener.

Dispensing with Mini pumps

Most problems related to the curing of epoxy can be traced to the wrong ratio of resin and hardener. To simplify metering, use calibrated WEST SYSTEM Mini Pumps to dispense the correct working ratio of resin and hardener. (For one full pump stroke of resin use one full pump stroke of hardener.) Depress each pump head fully and allow the head to return completely before beginning the next stroke. Partial strokes will give an incorrect ratio. Read the pump instructions before using the pumps and verify the correct ratio before using the first mix on a project. Recheck the ratio whenever curing problems are experienced. One full depression of each pump will give approximately 24g of mixed epoxy.

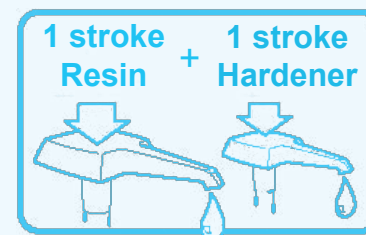

With Mini Pumps - One full pump stroke of resin for one full pump stroke of hardener will give the correct ratio.

Dispensing without Mini Pumps—Weight/volume measure

To measure 105 Resin and 205 or 206 Hardener by weight, combine five parts resin with one part hardener. Small quantities can be mixed by volume at the same ratio. To measure 105 Resin and 207 or 209 Hardener by volume, combine three parts resin with one part hardener (by weight, 3.5 parts resin : 1 part hardener).

First time users

If using WEST SYSTEM epoxy for the first time, begin with a small test batch to get the feel for the mixing and curing process before applying a mix to the job in hand. This will demonstrate the open time for the resin/hardener mix at the present ambient temperature and give assurance that the mix ratio is correctly metered. Mix small batches until confident of the handling characteristics of the epoxy.

Mixing

Thoroughly blend the two ingredients for 2 minutes - longer in cooler temperatures (*Figure 3*). Scrape the sides and bottom of the pot when mixing. If using the mix for coating, after mixing, quickly pour into a roller pan to extend the open time.

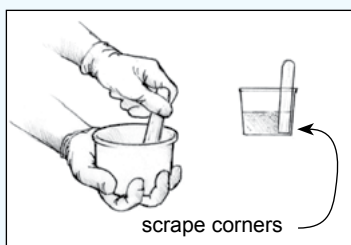

Figure 3 Stir resin and hardener thoroughly together for 2 minutes, longer in cooler temperatures.



WARNING! Curing epoxy generates heat. Do not fill or cast layers of epoxy thicker than 10 to 12mm – thinner if enclosed by foam or other insulating material. If left to stand for the full pot life in a plastic mixing cup, the mixed epoxy will generate enough heat to melt the plastic. If a pot of mixed epoxy begins to exotherm (heat up), quickly move it outdoors. Avoid breathing the fumes. Do not dispose of the mixture until the reaction is complete and the material has cooled.

2.5 Adding Fillers and Additives

Fillers

Throughout this booklet, reference to epoxy or resin/hardener mixes is defined as mixed resin and hardener without fillers added; thickened mixes or thickened epoxy will mean mixed resin and hardener with fillers added. Fillers are used to thicken epoxy for specific applications such as bonding or fairing.

After selecting an appropriate filler for the job in hand (selection guide - page 34), use it to thicken the epoxy to the desired consistency. The viscosity or thickness of a mix required for a specific job is controlled by the amount of filler added. There is no strict formula or measuring involved - visually judge the consistency which is best suited for the task in hand. *Figure 5* gives a general guide to the differences

between unthickened epoxy and the three other consistencies referred to in this manual.

Always add fillers in a two-step process:

1. Mix the desired quantity of resin and hardener thoroughly before adding fillers. Begin with a small batch - allow room for the filler.
2. Blend in small quantities of the appropriate filler until the desired consistency is reached (*Figure 4*). Ensure the filler is thoroughly blended before the mix is applied.



Figure 4 Stir in small quantities of filler until the desired consistency is reached.

For maximum strength, add only enough filler to completely bridge gaps between surfaces without sagging or running out of the joint or gap. A small amount should squeeze out of joints when clamped. When making fairing compounds, add as much 407 or 410 as can be blended in smoothly - for easy sanding, the thicker the viscosity, the better. Spread the mix into a thinner layer, either around the inside of the mixing cup or onto a flat non-porous surface or palette, to extend the working life.

CONSISTENCY	Unthickened	Slightly thickened	Moderately thickened	Maximum thickness
	"SYRUP"	"KETCHUP"	"MAYONNAISE"	"PEANUT BUTTER"
GENERAL APPEARANCE				
CHARACTERISTICS	Drips off vertical surfaces.	Sags down vertical surfaces.	Clings to vertical surfaces. Peaks fall over.	Clings to vertical surfaces. Peaks stand up.
USES	Coating, "wetting-out" before bonding, applying fibreglass, graphite and other fabrics.	Laminating/bonding flat panels with large surface areas, injecting with syringe.	General bonding, filleting, hardware bonding.	Gap filling, filleting, fairing, bonding uneven surfaces.

Figure 5 Epoxy can be thickened to the ideal consistency needed for a particular job. The procedures in this manual refer to four common consistencies: syrup, ketchup, mayonnaise and peanut butter.

Additives

Although additives are blended with mixed epoxy in a similar two-step process, they are not designed to thicken the epoxy. Additives give the epoxy additional physical properties when used as a coating and pigments provide a colour base for future overcoating with quality marine paint. Refer to the descriptions of the additives on page 48.

3. BASIC TECHNIQUES

The following procedures are common to the majority of repair or building projects – on the boat or in the home and regardless of the type of structure or material on which work is being carried out.

3.1 Surface preparation

Whether bonding, fairing or applying fabrics, the success of the application depends not only on the strength of the epoxy but also on how well the epoxy adheres to the surface to which it is being applied. Unless bonding to partially cured epoxy, the strength of the bond relies on the ability of the epoxy to mechanically “key” into the surface. Thus, the following three steps of surface preparation are a critical part of any secondary bonding operation.

For good adhesion, bonding surfaces must be:

1. Clean

Bonding surfaces must be free of any contaminants such as grease, oil, wax or mould release. Clean contaminated surfaces with WEST SYSTEM 850 Solvent. (Figure 6). Wipe the surface with fresh paper towels before the solvent dries. Clean surfaces before sanding to avoid abrading the contaminant into the surface. Follow all safety precautions when working with solvents.

2. Dry

All bonding surfaces must be as dry as possible for good adhesion. If necessary, accelerate drying by warming the bonding surface with a hot air gun, hair dryer or heat lamp (Figure 7). Use fans to move the air in confined or enclosed spaces. Be careful of condensation when working outdoors or whenever the temperature of the work environment changes.

3. Sanded

Thoroughly abrade hardwoods and non-porous surfaces with 80-grit aluminium oxide paper to provide a good mechanical “key” for the epoxy (Figure 8). Ensure the surface to be bonded is solid. Remove any flaking, chalking, blistering or old coating before sanding. Remove all dust after sanding.

The importance of the three operations detailed above cannot be stressed too strongly – for high strength, durable bonds, surfaces must be clean, dry and thoroughly abraded after removing previous surface coatings.



Figure 6 Clean the surface. Use a solvent, if necessary, to remove all contaminants.

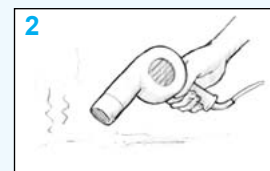

Figure 7 Dry the Surface. Allow wet surfaces to dry thoroughly or use heat or a fan to speed the drying.

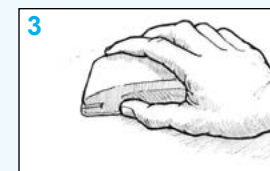

Figure 8 Sand non-porous surfaces. Provide a texture for the epoxy to key into.

Primary/Secondary bonding

Primary bonding relies on chemical linking of adhesive layers such as the wet lay-up of fibreglass laminate in a mould. All the layers of adhesive cure together in a single fused layer. Epoxy applied over partially cured epoxy will chemically link with it to form a primary bond. The ability to chemically link diminishes as the previous layer of epoxy cures and the bond becomes a secondary bond.

Secondary bonding requires a mechanical, rather than chemical linking of an adhesive to a material or cured epoxy surface. The adhesive must “key” into pores or scratches in the surface - a microscopic version of a dovetail joint. Correct surface preparation provides a texture that will help link the cured epoxy to the surface.

Special preparation for various materials

Cured epoxy - Amine blush can appear as a wax like film on cured epoxy surfaces. It is a by-product of the curing process and is more noticeable in cool, moist conditions. Amine blush can clog sandpaper and inhibit subsequent bonding but it is water soluble and can easily be removed. It is not unreasonable to assume it has formed on any cured epoxy surface.

To remove the blush, thoroughly wash the surface with clean water and an abrasive pad. Dry the surface with fresh paper towels to remove the dissolved blush before it dries on the surface. Sand any remaining glossy areas with 80-grit sandpaper and clean.

Wet-sanding will also remove the amine blush. If a release fabric (peel ply) is applied over the surface of fresh epoxy, amine blush will be removed when

Removing epoxy

Removing uncured or non-curing epoxy. Scrape as much material as possible from the surface using a stiff metal or plastic scraper - warm the epoxy to lower its viscosity. Clean the residue with WEST SYSTEM 850 Cleaning Solvent. (Follow safety warnings on solvents and provide adequate ventilation). Allow solvents to dry before recoating. After recoating wood surfaces with epoxy, brush the wet epoxy (in the direction of the grain) with a wire brush to improve adhesion.

Removing fibreglass cloth applied with epoxy. Use a heat gun to warm and soften the epoxy. Begin in a small area near a corner or edge. Apply heat until a putty knife or chisel can be slipped under the cloth. Grab the edge with a pair of pliers and slowly pull up the cloth while heating just ahead of the separation. On large areas, use a utility knife to score/cut the glass and remove in narrower strips. Resulting surface texture may be coated or remaining epoxy may be removed as follows.

Removing cured epoxy coating. Use a heat gun to soften the epoxy. Heat a small area and use a paint or cabinet scraper to remove the bulk of the coating. Sand the surface to remove the remaining material. Provide ventilation when heating epoxy.

the release fabric is peeled from the cured epoxy and no additional sanding is required.

Epoxy surfaces that are still tacky *i.e.* **not fully cured**, may be bonded to or coated with epoxy **without washing or sanding**. Before applying coatings other than epoxy (paints, bottom paints, varnishes, gelcoats, etc.), allow epoxy surfaces to cure fully, then wash, sand, clean and **follow coating manufacturer's instructions**.

Hardwoods - Thoroughly abrade with 80-grit paper and remove dust before coating.

Teak/oily woods - Wipe the surface with WEST SYSTEM 850 solvent or pure acetone and when the solvent has evaporated, abrade with 80-grit paper. Clean the sanding dust away and then wipe the abraded surface with solvent – the solvent dries the oil at the surface and allows the epoxy to penetrate. Ensure the solvent has evaporated before coating but apply the epoxy within 15 minutes of the solvent wipe.

Porous woods - No special preparation needed but it is advisable to abrade with a medium grit paper to open pores. Remove dust.

Metals - Metals must have all previous surface pre-treatments and contaminants e.g. rust removed, taking the surface back to the bare metal by thoroughly degreasing then abrading with a coarse paper such as 80-grit or grit blasting and then degreasing again. The use of an adhesion promoter is advised on non-ferrous metal substrates. Given below is the preparation for the more common metals used in boat building.

Mild Steel - Degrease and then thoroughly abrade (ideally, grit blast), removing all contamination to expose bright metal. Apply epoxy as soon as possible and certainly within 4 hours after surface has been prepared.

Stainless Steel - Degrease and then thoroughly abrade (ideally, grit blast), removing all contamination and the stainless coating to expose bright metal. Apply epoxy as soon as possible and certainly within 4 hours after surface has been prepared. Then (wet) sand the epoxy into the surface. Recoat or bond after first coat gels.

Aluminium - Non-anodised material must be degreased and either thoroughly abraded or chemically etched, (sulphuric acid/sodium dichromate solution or branded aluminium etch compound).

Anodised aluminium and anodised aluminium alloys - must be bonded as quickly as possible after degreasing and abrading and certainly within 30 minutes.

Hard anodised aluminium alloy - must be stripped by abrasive blasting or by etching in sulphuric acid/sodium dichromate solution or branded aluminium etch compound. Unstripped metal is not suitable for bonding.

Polyester/GRP - Remove contamination with WEST SYSTEM 850 Solvent. Thoroughly abrade with 80-grit paper to a dull finish and remove dust.

Ferrocement - Remove all previous paints and coatings by wet sand blasting - this

is less aggressive than using dry sand and should not damage the sound surface. If after blasting, laitance is visible on the surface or rust from the reinforcing wires can be seen, then it is necessary to wash with dilute solution of hydrochloric acid - this should be fresh water with a 4% to 5% addition of hydrochloric acid. Wash thoroughly with water and allow to dry completely before coating.

Concrete - Remove all previous coatings and abrade with a stiff wire brush. Remove all dust and debris before coating.

Plastic - Adhesion varies. If a plastic is impervious to solvents such as acetone, epoxy generally will not bond to it. Soft, flexible plastics such as polyethylene, polypropylene, nylon and Plexiglas fall into this category. Hard, rigid plastics such as PVC, ABS, polycarbonate and styrene provide better adhesion with good surface preparation and adequate bonding area. After sanding, flame oxidizing (by quickly passing the flame of a propane torch over the surface without melting the plastic) can improve bonding in some plastics.

It's a good idea to conduct an adhesion test on any plastic (or any other material) that you are uncertain about.

For best results when working with plastic use WEST SYSTEM G/flex epoxy see Specialty Epoxies – page 44

3.2 Bonding (gluing)

This section refers to two types of structural bonding. Two step bonding is the preferred method for most situations because it promotes maximum epoxy penetration into the bonding surface and prevents resin starved joints. Single step bonding is occasionally used when joints have minimal loads and excess absorption into porous surfaces is not a problem. In both cases, to achieve the ultimate bond strength, work the epoxy into the surface with a roller or brush.

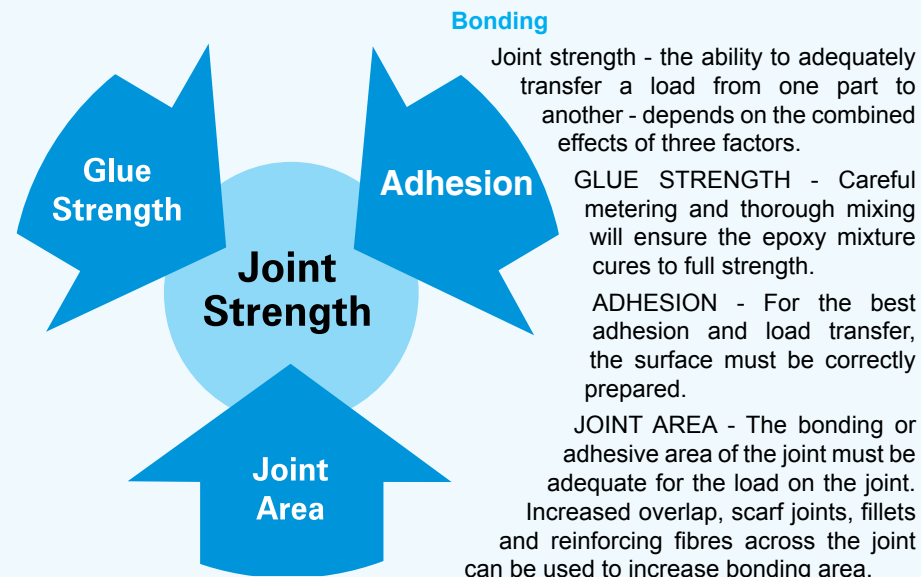

Before mixing epoxy, ensure all parts to be bonded fit properly and that surface preparation has been completed. (See *surface preparation section 3.1 page 11*). Gather all clamps and tools necessary for the operation and cover any areas that need protection from spills.

Two-step bonding

1. Apply a resin/hardener mix to the surfaces to be joined (*Figure 9*). This is called “wetting-out” or “priming” the bonding surfaces. The epoxy is applied with a disposable brush in small or tight areas; wet-out larger areas with a foam roller or by spreading the resin/hardener mix evenly over the surface with a plastic squeegee/spreader. Proceed with step two immediately or any time before the wet-out coat becomes tack free.

2. Modify the resin/hardener mix by stirring in the appropriate filler until it becomes thick enough to bridge any gaps between the mating surfaces and to prevent “resin-starved” joints. Apply an even coat of the thickened epoxy to **one** of the bonding surfaces, sufficient so that a small amount will squeeze out when the surfaces are joined together (*Figure 10*).

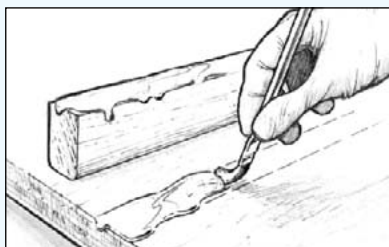

Figure 9 Apply resin/hardener mixture to the bonding surfaces.

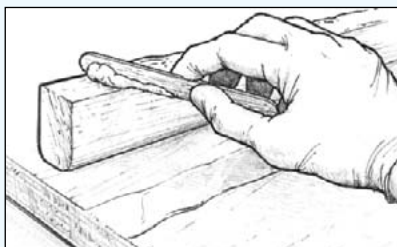

Figure 10 Apply thickened epoxy to one of the bonding surfaces.

As already stated, the thickened epoxy can be applied immediately over the wet out surface or any time before the epoxy becomes tack free. For most small bonding operations, add the filler to the resin/hardener mix remaining in the batch that was used for the wet-out. Mix enough resin/hardener for both steps. Add the filler quickly after the surface is wet out and allow for a shorter working life of the mix.

3. Clamp components. Attach clamps as necessary to hold the components in place. Use only enough clamping pressure to squeeze a small amount of the thickened mix from the joint, indicating that the epoxy is making good contact with both mating surfaces (*Figure 11*). Do not squeeze all the thickened mix from the joint by using too much clamping pressure.

4. Remove or shape excess adhesive that squeezes out of the joint as soon as the joint is secured with clamps. A WEST SYSTEM 804 mixing stick with one end sanded to a chisel edge is an ideal tool for removing the excess (*Figure 12*). Allow to cure thoroughly before removing clamps.

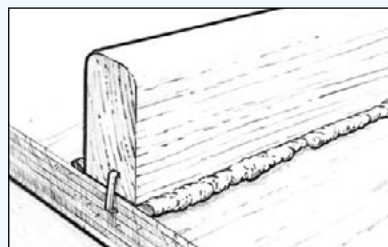

Figure 11 Clamp components in place before the epoxy gels.

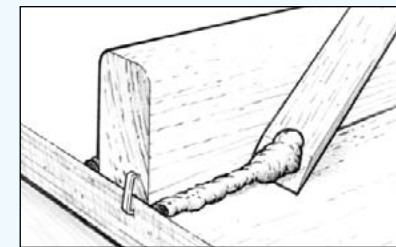

Figure 12 Remove or shape excess epoxy that squeezes out of the joint.

Single-step bonding

Single-step bonding is applying a thickened epoxy mix directly to both bonding surfaces without first wetting out the surfaces with a resin/hardener mix. However, it is strongly recommended that the epoxy is thickened no more than is necessary to bridge gaps in the joint (the thinner the mix, the more it can penetrate the surface) and this method is not used for highly-loaded joints or for bonding either end grain or other porous surfaces.

3.3 Bonding with fillets

A fillet is a cove-shaped application of thickened epoxy that bridges an inside corner joint. It is an excellent technique for bonding components because the surface area of the bond is increased and serves as a structural brace. All joints that will be covered with glasscloth will require a fillet to support the cloth at the inside corner of the joint.

The procedure for bonding with fillets is the same as normal bonding but, instead of removing the squeezed-out thickened epoxy after the components are clamped in position, the epoxy/filler blend is shaped into a fillet. For larger fillets, as soon as the bonding operation is complete and before the squeezed-out epoxy becomes tack free, add more thickened mix to the joint and shape into a fillet.

1. Bond components as described in Bonding (page 13).
2. Shape and smooth the squeezed-out thickened epoxy into a fillet by drawing a rounded filleting tool (a mixing stick is ideal) along the joint, dragging excess material ahead of the tool and leaving a smooth cove-shaped fillet bordered on each side by a clean margin. Some excess filleting material will remain outside the margin (*Figure 13*) which can be used to refill any voids. Smooth the fillet until you are satisfied with the appearance. A mixing stick will leave a fillet with about a 10mm radius. For larger fillets, an 808 Plastic Squeegee is recommended, cut to shape or bent to the desired radius.

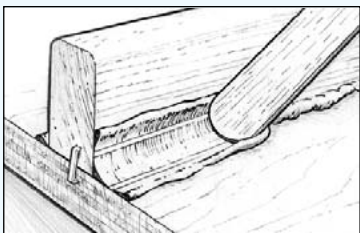

Figure 13 Shape and smooth the fillet.

Apply additional thickened epoxy to fill voids or make larger fillets. Add sufficient mix along the joint line with the rounded mixing stick to create the desired size of fillet. For longer or multiple fillets, empty caulking gun cartridges or disposable cake decorating bags can be used. Cut the plastic tip to lay a bead of thickened epoxy large enough for the desired fillet size. Heavy duty, sealable food storage bags with one corner cut off may also be used.

3. Clean up the remaining excess material outside the margin by using a mixing stick or a putty knife (*Figure 14*). Glasscloth or tape may be applied over the fillet area before the fillet has cured (or after the fillet is cured and sanded).

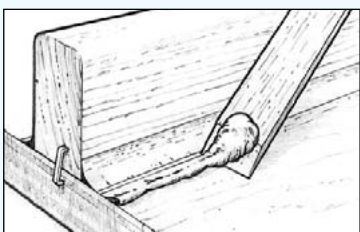

Figure 14 Clean up the excess epoxy outside the fillet margin.

4. When the fillet has fully cured, sand smooth with 80-grit sandpaper. Wipe the surface clean of dust and apply two or three coats of resin/hardener over the entire fillet area before final finishing.

3.4 Bonding fasteners and hardware

Installing screws and other threaded fasteners with WEST SYSTEM epoxy dramatically improves the load carrying capacity of the fastener by spreading the load into a greater area of the substrate. There are several methods of hardware bonding dependent upon the loads carried by the hardware.

Basic fastener bonding

For improved pullout strength and eliminating moisture ingress, the easiest method is to simply wet out stripped fastener holes and new pilot holes before installing the screws. Epoxy penetrates the fibre around the hole, effectively increasing the fastener diameter.

1. Wet out a standard-size pilot hole and work the resin/hardener mix into the hole with a pipe cleaner or syringe (*Figure 15*). Thicken a second coat of epoxy as necessary for stripped or oversized holes.

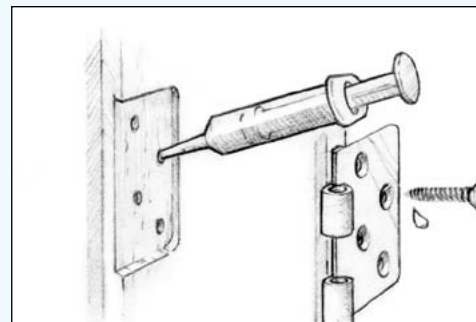

Figure 15 Wet out a standard pilot hole and install the fastener.

2. Insert the fastener in the hole and allow the epoxy to cure.

Advanced fastener bonding

For greater strength and stability, drill oversized holes to increase the exposed substrate area and the amount of epoxy around the fastener. If the fastener/hardware can be clamped by other means, the oversized hole can be extended to the end of the fastener.

1. Drill oversized holes approximately $\frac{2}{3}$ the depth of the fastener. The hole diameter is 6mm larger than the fastener diameter. (*Figure 16a*).

2. Drill a normal sized pilot hole at the bottom of the oversized hole to the full length of the fastener. The normal sized pilot hole serves to hold or clamp the hardware in position until the epoxy cures.

3. Wet out the holes and the fastener with a resin/hardener mix. Allow the epoxy to thoroughly soak into the exposed end grain of the wood.

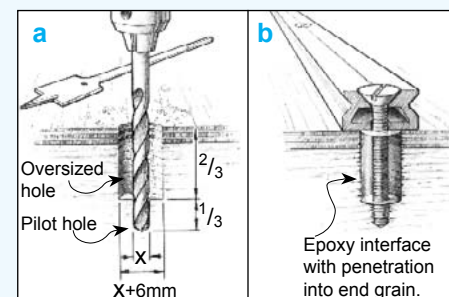

Figure 16 Drill oversized holes to increase the exposed substrate area and the amount of epoxy around the fastener.

4. Fill the hole with thickened epoxy/adhesive filler. Use 404 High-Density (preferred) or 406 Colloidal Silica.

5. Install the fasteners with just enough force to hold the hardware in place. Allow the epoxy to cure thoroughly before applying load to the hardware (*Figure 16b*).

Bonding hardware

Bonding hardware goes much further than only bonding the fasteners. By bonding the hardware base to the surface, the hardware load capacity is significantly

increased by providing a solid bearing surface for the hardware. It also seals the wood underneath and is a stronger, longer lasting attachment than bonding the fasteners only. It is especially useful to mount hardware on surfaces which are not level, curved or uneven.

1. Prepare the mounting surface and the hardware base for good adhesion (see *surface preparation - page 10*).
2. Wet out the oversized hole with epoxy. Allow the epoxy to soak into the exposed end grain of the wood (as with fastener bonding).
3. Coat the bottom contact surface of the hardware with unthickened epoxy. Wire brush or sand the wet epoxy into the surface with 50-grit sandpaper. Sanding the base, coated with epoxy, exposes the epoxy directly to fresh metal avoiding any oxidation of the metal.
4. Inject a non-sagging epoxy/404 or 406 mix into the hole. Use sufficient mix to ensure there are no voids in the hole after inserting the fastener. Coat the bottom of the hardware and the fastener threads with thickened epoxy (*Figure 17*).

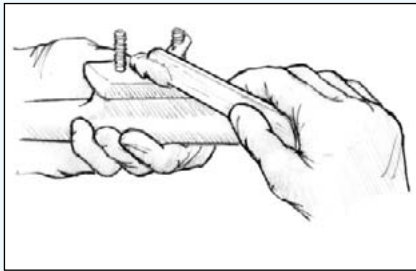

Figure 17 Coat the hardware bottom and the fastener threads with thickened epoxy.

5. Place the hardware in position. Insert and tighten fasteners until a small quantity of mix squeezes out of the joint (*Figure 18*).

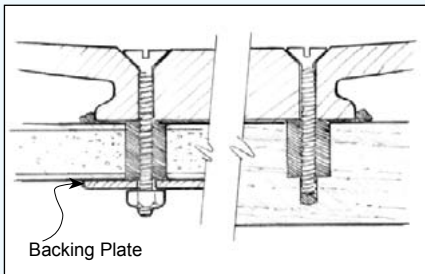

Figure 18 Tighten the fasteners until a small amount of epoxy squeezes from the joint.

6. Remove excess epoxy or shape into a fillet. Allow the epoxy to cure for at least 24 hours at 15°C minimum before applying load to the hardware. Allow more time in cool weather.

Casting a base

Use thickened epoxy to cast a base under the hardware when mounting hardware to a curved or uneven surface or mounting hardware at an angle to the surface.

1. Prepare the fasteners, holes, substrate and base as described above.
2. Bond small blocks to the substrate to support the base at the desired height and position (e.g., *winch base, Figure 19"A*").

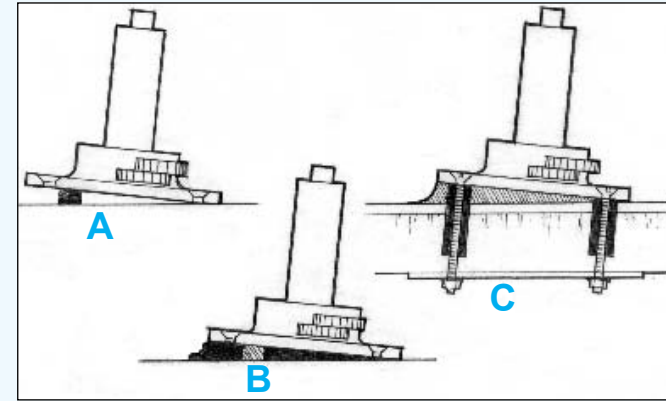

Figure 19 Support the base in position with blocking - apply enough thickened epoxy to fill the void.

3. Apply enough thickened epoxy – non-sagging, peanut butter consistency – to fill the volume below the required position of the hardware to a level marginally higher than the blocks. If the gap between the base and the surface is over 12mm fill the gap in two separate layers to avoid exotherm.
4. Place the hardware in position, resting on the blocks (*Figure 19"B*") and install the fasteners.
5. Smooth the excess epoxy into the desired fillet shape around the base (*Figure 19"C*"). Allow the epoxy to cure fully before loading. Protect exposed epoxy from UV. (see *finish coating page 29*).

Bonding studs

Bond threaded rods or studs into the substrate (instead of bolts or screws) and attach the hardware with nuts. This variation is appropriate for many engine, motor or machine installations. Coat the base of the hardware with wax/mould release to make it removable. Although the hardware is not “bonded” to the substrate, the epoxy still provides a bearing surface that perfectly matches and supports the base of the hardware.

1. Prepare the studs/threaded rods by waxing the upper ends (above the surface) and cleaning the lower ends (below the surface).
2. Place a nut and washer on the studs, wet out the lower ends and push them into the epoxy filled holes. Allow the epoxy to cure thoroughly before attaching hardware and tightening the nuts (*Figure 20*).

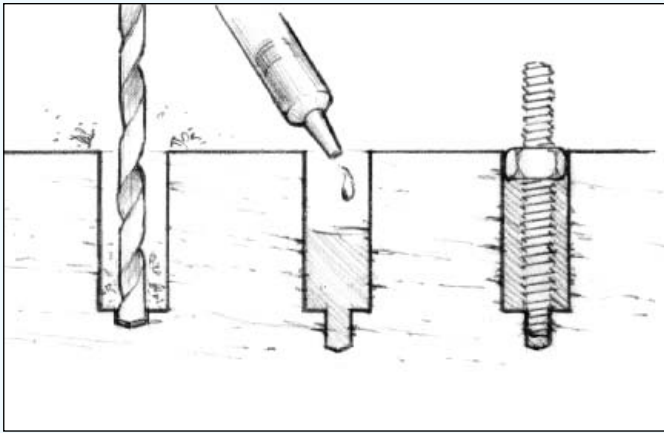

Figure 20
Bond threaded rods or studs into the substrate as an alternative for easily removable hardware.

Removing fasteners

If a fastener needs to be removed at a future date, coat the threads with wax or mould release (contaminating the surface sufficiently to prevent a good bond).

Remove a permanently bonded fastener by applying heat to the head of the fastener with a soldering iron or propane torch. Use a heat shield to protect the surrounding area. Heat will travel down the fastener, softening the epoxy with which it is in contact. After heating the epoxy should soften enough to allow the fastener to be backed out. Allow more time for heat to travel along longer and/or larger diameter fasteners.

3.5 Laminating

The term “laminating” refers to the process of bonding together a number of relatively thin sheets, like plywood, veneers, fabrics or core material, to create a composite. A composite may be any number of layers of the same material or combinations of different materials. Methods of epoxy application and clamping will differ depending on the materials being laminated.

A quick method to apply epoxy for laminating is to use a foam roller. An even faster method for large flat surfaces is to simply pour the resin/hardener mix onto the middle of the panel/veneer/ fabric and spread the epoxy evenly over the surface with a plastic spreader. Apply thickened mixes with an 809 Notched Spreader.

Using staples or screws is the most common method of clamping when there is a solid

Clamping

Any method of clamping is suitable to prevent movement between the parts being joined. Methods of clamping include spring clamps, “C” clamps and adjustable bar clamps, rubber bands cut from inner tubes, packaging tape, applying weights, and vacuum bagging. When placing clamps near epoxy covered areas, use polyethylene sheeting or peel ply under the clamps so they do not inadvertently bond to the surface. Staples, nails or drywall screws are often used where conventional clamps are unsuitable. Any fasteners that need to remain should be of a non-corroding alloy such as bronze. In some cases, the thickened epoxy or gravity will hold parts in position without clamps. Avoid excessive clamping pressure.

material on which to fasten. An even distribution of weights will suffice when laminating over a base that will not hold mechanical fixings, such as a foam or honeycomb core material.

Vacuum bagging is a specialized clamping method for laminating a wide range of materials. Using a vacuum pump and plastic sheeting, the atmosphere is used to apply perfectly even clamping pressure over all areas of a panel regardless of the size, shape or number of layers. For detailed information on vacuum bagging, refer to 002-150 Vacuum Bagging Techniques.

3.6 Fairing

Fairing refers to the filling and shaping of low or uneven areas so they blend with the surrounding surfaces and appear “fair” to the eye and touch. After major structural assembly has been completed, final fairing can be accomplished easily with WEST SYSTEM epoxy and low-density fillers.

1. Prepare the surface as detailed for bonding (*page 10*). Sand smooth any bumps or ridges on the surface and remove all dust from the area to be faired.
2. Wet out porous surfaces with resin/hardener mix (*Figure 21*).
3. Mix resin/hardener and 407 Low-Density or 410 Microlight® filler to a peanut butter consistency. The thicker the mix, the easier it will be to sand when cured.

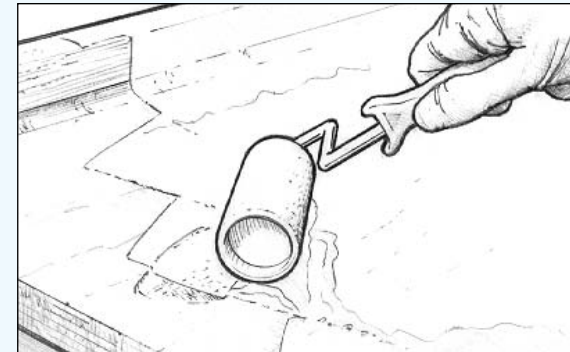

Figure 21 Wet out porous surfaces before applying fairing compound.

4. Trowel the thickened epoxy mix onto the wetted surface with a plastic spreader, working it into all voids and depressions. Smooth the epoxy to the desired shape, leaving the mix slightly higher than the surrounding area (*Figure 22*). Remove any excess thickened epoxy before it cures. If filling voids over 12mm deep, apply the fairing mix in several applications allowing each application to partially cure before proceeding and/or use 206 Slow Hardener® or 209 Extra Slow Hardener™, depending on temperature.

Note: On vertical and overhead surfaces, allow the wet-out coat to gel before applying the fairing compound which may sag or slide off the fresh wet-out coat. Apply the fairing compound while the wet-out coat is still tacky.

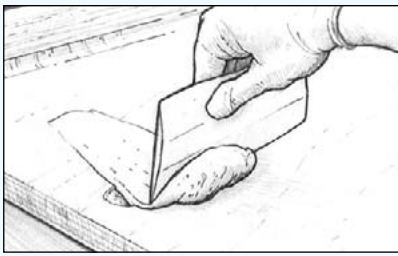

Figure 22 Apply fairing compound to fill all voids and smooth to shape.

5. Allow the final application of thickened epoxy to cure thoroughly.
6. Sand the fairing material to blend with the surrounding contour (*Figure 23*). Begin with 50-grit sandpaper if it is necessary to remove a lot of fairing material. Use 80-grit paper when close to the final contour.



Figure 23 Sand cured fairing compound to desired contour.



CAUTION! Wear a dust mask when sanding cured epoxy. Remove the sanding dust and fill any remaining voids following the same procedure.

7. When satisfied with the fairness, apply two or three coats of resin/hardener mix to the area with a disposable brush or roller. Allow the final coat to cure thoroughly before final sanding and finishing. **Note:** 410 filler can be affected by the solvents in most paints. Surfaces faired with with 410 Filler must be sealed with epoxy before applying any solvented paints.

3.7 Applying woven cloth and tape

Glass cloth may be applied to surfaces by two methods to provide reinforcement and/or abrasion resistance. It is usually applied after fairing and shaping are completed and before the final coating operation. It is also applied in multiple layers *i.e.* laminated and in combination with other materials to build composite parts.

The “wet” method refers to the cloth being applied to an epoxy-coated surface before the coating reaches final cure. The “dry” method is to apply the cloth over a dry surface and then impregnate the glass with epoxy. **The wet method is preferred whenever possible.**

Wet method

By working with small quantities of epoxy, it is possible to work at a comfortable pace over quite large areas to be reinforced.

1. Prepare the surface for bonding as discussed in surface preparation (page 10).
2. Pre-fit and trim the cloth to size. Roll the cloth neatly so that it may be conveniently rolled back into position later.
3. Roll a heavy coat of epoxy on the surface.
4. Unroll the glass cloth into position over the wet epoxy. Surface tension will hold most cloths in position. (If applying the cloth vertically or overhead, it is possible to wait until the epoxy becomes a little tacky). Work out wrinkles by lifting the edge of the cloth and smoothing from the centre with a gloved hand or a squeegee/spreader. If cutting a pleat or notch in the cloth, lay it flat on a curve or corner, make the cut with sharp scissors and temporarily overlap the edges.
5. Any areas of cloth which appear to be dry, (white in appearance) apply more epoxy with a foam roller.
6. Remove the excess epoxy with a squeegee (*Figure 24*), using long overlapping strokes of uniform pressure. The object is to remove the excess epoxy that may allow the cloth to “float off” the surface but avoid creating dry spots by exerting too much pressure on the squeegee. Excess epoxy appears as a shiny area while a properly wet out surface appears evenly transparent with a smooth cloth texture. Subsequent coats of epoxy will fill the weave of the cloth.

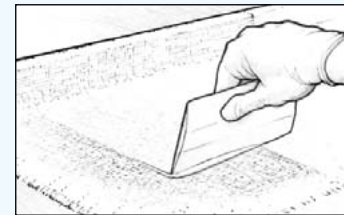

Figure 24 Squeegee away excess epoxy before it begins to gel.

7. Further layers of cloth may be applied immediately by repeating the steps above.
8. Trim the excess (*Figure 25*) and overlapped cloth after the epoxy has reached its initial cure. The cloth will cut easily with a sharp utility knife as long as the epoxy is not fully cured. If required, trim overlapped cloth as follows.

Clear wood finishes (stripper canoes, etc.)

An alternative wet out method is to lay the epoxy onto the fabric with a short bristled brush. Dip the brush in the epoxy and lay the epoxy onto the surface with a light even stroke. Do not force the epoxy into the cloth, which may trap air in the fabric and show through the clear finish. Apply enough epoxy to saturate the fabric and the wood below. After several minutes, lay on additional epoxy to dry (white) areas. If epoxy appears milky due to high humidity or overworking, warm the surface by passing a heat gun or hair dryer over the surface. Use low heat to avoid out-gassing. Be sure to use 207 Hardener for clear finishes.



Figure 25 Trim excess cloth after the epoxy gels but before it cures hard.

- a) Place a metal straightedge on top of and midway between the two overlapped edges.
- b) Cut through both layers of cloth with a sharp utility knife (*Figure 26*), being very careful not to cut too deeply.

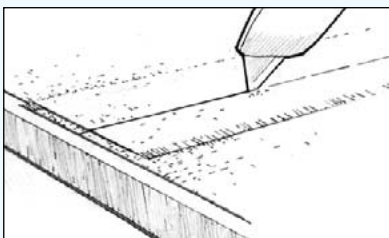

Figure 26 Trim overlapped cloth after the epoxy gels.

- c) Remove the top-most trimming and then lift the opposite cut edge to remove the overlapped trimming (*Figure 27*).

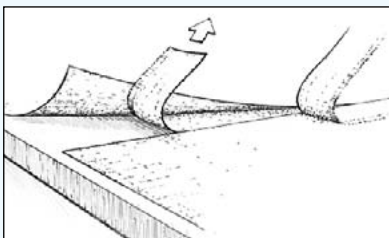

Figure 27 Remove the topmost trimming, lift the opposite cut edge to remove the overlapped trimming.

- d) Re-wet the underside of the raised edge with epoxy and smooth into place.

The result should be a near perfect butt joint, eliminating double cloth thickness. However, a lapped joint is stronger than a butt joint, so if appearance is not important, it may be advisable to leave the overlap and fair in the unevenness after coating. Alternatively use WEST SYSTEM 743 tapered edge cloth to eliminate the need to butt join, contact Wessex Resins & Adhesives Limited or your local distributor for further information.

Any remaining irregularities or transitions between cloth and substrate can be faired by using an epoxy/filler fairing compound if the surface is to be painted. Any fairing completed after the final glass cloth layer should receive several additional coats of epoxy over the faired area.

9. Coat the surface to fill the weave before the wet-out becomes tack free (*Figure 28*). Follow the procedures for final coating in the next section. It will take

two or three coats to completely fill the weave of the cloth and to allow for a final sanding that will not damage the cloth.

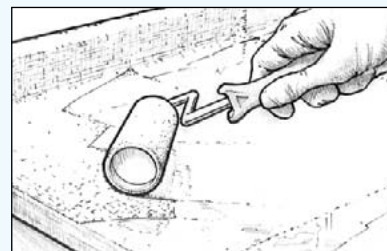

Figure 28 Coat the surface to fill the weave before the wet-out becomes tack free.

Dry method

1. Prepare the surface for bonding (*see surface preparation page 10*).
2. Position the cloth over the surface and cut it 30 mm larger on all sides. If the surface area to be covered is larger than the cloth size, allow multiple pieces to overlap by approximately 50 mm. On sloped or vertical surfaces, hold the cloth in place with masking or duct tape, or with staples.
3. Mix a small quantity of epoxy (three or four pumps each of resin and hardener).
4. On horizontal surfaces, pour a small pool of resin/hardener near the centre of the cloth but it is essential to use a roller or brush for wetting cloth on vertical surfaces.
5. Spread the epoxy over the cloth surface with an 808 Plastic Squeegee, working the epoxy gently from the pool into the dry areas (*Figure 29*). As the fabric is wet out it becomes transparent, indicating the cloth has absorbed sufficient epoxy. If applying cloth over a porous surface, ensure that sufficient epoxy is left to absorb into both the cloth and the surface below. Try to limit the amount of squeegeeing as excessive “work” on the wet surface produces minute air bubbles which are placed in suspension in the epoxy. This is especially important if a clear finish is required.

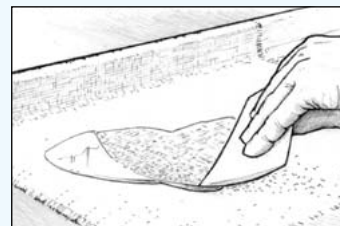

Figure 29 Spread the epoxy over the cloth surface with a plastic spreader.

6. Continue pouring and spreading (or rolling) small batches of epoxy from the centre towards the edges, smoothing wrinkles and positioning the cloth. Check for dry areas (especially over porous surfaces) and re-wet as necessary before proceeding to the next step. If cutting a pleat or notch in the cloth, lay it flat on a compound curve or corner, make the cut with a pair of sharp scissors and temporarily overlap the edges.

7. Now refer to Steps 5, 6, 7, 8 and 9 detailed above in the “wet method” to complete the procedure.

3.8 Epoxy barrier coating

The object of barrier coating is to build up an epoxy thickness that provides an effective moisture barrier and a smooth base for final finishing.

Apply a minimum of two coats of WEST SYSTEM epoxy for an effective moisture barrier. Apply three coats if sanding is to be carried out. Moisture protection will increase with additional coats and, in the case of osmosis repair and protection, six coats or about a thickness of 600 microns must be applied. Six coats, with 422 Barrier Coat Additive™ in the final five coats, provides maximum moisture protection. Additives or pigments should not be added to the first coat. **Do not add thinners or solvents to WEST SYSTEM epoxy.**

Disposable, thin urethane foam rollers, such as WEST SYSTEM 800 or 790 Roller Covers, allow greater control over film thickness, are less likely to cause the epoxy to exotherm and leave less stipple than thicker roller covers. Cut the covers into narrower widths to reach difficult areas or for long narrow surfaces like stringers. A paint brush can be used for smaller areas, if the bristles are stiff enough to spread the epoxy to an even film.

Complete all fairing and cloth application before beginning the final coating. Allow the temperature of porous surfaces to stabilise before coating otherwise, as the material warms up, air within the porous material may expand and pass from the material (out-gassing) through the coating and leave bubbles in the cured coating.

1. Prepare the surface for bonding (*see surface preparation page 10*).
2. Mix only as much resin/hardener as can be applied during the open time of the mix. Pour the epoxy into a roller pan as soon as it is mixed thoroughly.
3. Load the roller with a moderate amount of the epoxy. Roll out the excess on the raised section of the roller pan to obtain a uniform coating on the roller.
4. Roll lightly and randomly over an area approximately 600mm x 600mm to transfer the epoxy evenly over the area (*Figure 30*).

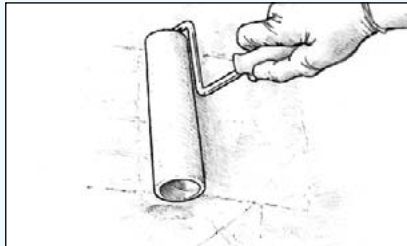

Figure 30 Roll lightly and randomly over a small area. Spread the epoxy into a thin even film.

5. As the roller dries out, increase pressure to spread the epoxy into a thin even film. Increase the coverage area if necessary to spread the film more thinly and evenly. **The thinner the film, the easier it is to keep it even and avoid runs or sags in each coat.**

6. Finish the area with long, light, even strokes to reduce roller marks. Overlap the previously coated area to blend both areas together.

7. Coat as many of these small working areas as possible with each batch. If a batch begins to thicken before it can be applied, discard it and mix a fresh, smaller batch.

8. “Tip off” the coating by dragging a foam roller brush lightly over the fresh epoxy in long, even, overlapping strokes after each batch is applied. Use enough pressure to smooth the stipple, but not enough to remove any of the coating (*Figure 31*). Alternate the direction in which each coat is tipped off, 1st coat vertical, 2nd coat horizontal, 3rd coat vertical, etc. A WEST SYSTEM 800 Roller Cover can be cut into segments to make an excellent “tipping” brush.

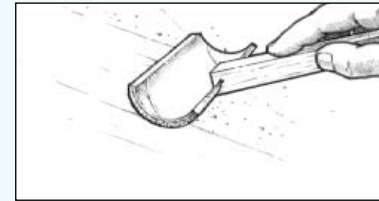

Figure 31 Tip off the coating by dragging a foam roller brush lightly over the fresh epoxy.

Recoating

Apply second and subsequent coats of epoxy following the same procedures. Ensure the previous coat is still tacky, but has cured firmly enough to support the weight of the next coat. To avoid sanding between coats, apply all coats in the same day. After the final coat has cured overnight, wash with clean water and abrade the surface to prepare for the final finish. *See Special Preparation - Cured epoxy on page 11.*

3.9 WEST SYSTEM Epoxy and Barrier Coating for Osmosis repair.

Osmosis, otherwise known as gel-coat blistering, is a complex phenomenon. The technical issues and repair instructions are contained in our specialist manual “**Gelcoat Blisters, A guide to Osmosis repair**”. It is essential to fully read, understand, and follow the instructions contained in it when considering a treatment. Any such treatments should only be carried out under the close supervision of a qualified Marine Surveyor or by an experienced boatyard or Contractor who has clear evidence of successful past treatments. Specialist yards or Contractors will have links with a qualified experienced surveyor and will usually obtain a full report prior to commencing a treatment. We strongly recommend that advice is sought from a qualified Marine Surveyor concerning a particular hull prior to the commencement of any treatment. Because of the variability of hull constructions and the complexity of the Osmosis phenomenon there can be no guarantee of a 100% success rate in treatments. Recurrence is always a possibility but by following these instructions we believe that the risks of recurrence will be minimised.

3.10 Final surface preparation

Correct finishing techniques will not only add beauty, but will also protect surfaces from ultraviolet light which will break down the epoxy over a long period of time. The most common methods of finishing are painting or varnishing. These coating systems protect the epoxy from ultraviolet light and require proper preparation of the surface before application.

Preparation for the final finish is just as important as it is for recoating with epoxy. The surface must be clean, dry and sanded and free of amine blush.

1. Allow the final epoxy coat to cure thoroughly.
2. Wash the surface with a Scotch-brite™ pad and water to remove the amine blush. Dry with paper towels.
3. Sand to a smooth finish (*Figure 32*). If there are runs or sags, begin sanding with 80-grit paper to remove the highest areas. Sand until the surface feels and looks fair. Complete sanding with the appropriate grit for the type of coating to be applied - check coating instructions. Paint adhesion partly relies on the mechanical grip of the paint keying into the sanding scratches in the surface of the epoxy. If a high-build or filling primer is to be applied, 80-100 grit is usually sufficient. For primers and high-solids coatings, 120-180 grit may be adequate. Finishing with 180 grit paper is often recommended for coatings with high-gloss finishes. Grits finer than this may not provide enough "tooth" for good adhesion and may promote sags and runs. Always follow the paint manufacturer's recommendations for surface preparation. Wet sanding is preferred by many people because it reduces sanding dust and in addition, Steps 2 and 3 above become one operation.

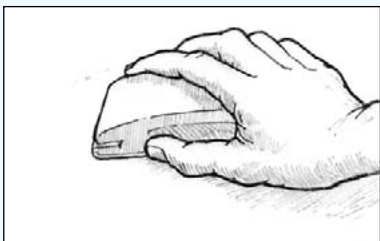

Figure 32 Sand to a smooth finish.

4. When satisfied with the texture and fairness of the surface, rinse the surface with fresh water which should flow evenly without beading or fisheyeing. If the rinse water forms into droplets or beads (a sign of contamination), wipe the area dry with a paper towel, then wet sand again until all water droplets are eliminated. (*Figure 33*).



Figure 33 Rinse the surface with fresh water after sanding.

Proceed with the final coating after the surface has dried thoroughly. To reduce

the possibility of contamination, it is advisable to begin coating within 24 hours of the final sanding. Follow the paint manufacturer's instructions but we suggest making a test panel to evaluate the degree of surface preparation required and the compatibility of the finish system.

3.11 Finish coatings

Coating function

Paint or varnish applied over an epoxy barrier coat is intended to decorate the surface and protect the epoxy from sunlight. In so doing, the finish coating extends the life of the epoxy moisture barrier which, in turn, provides a stable base that extends the life of the finish coating. Together, the two form a protective system far more durable than either coating by itself.

Protection from sunlight is a primary consideration in the selection of a final coating. Long term UV (ultraviolet) protection of the barrier coat depends on the effectiveness with which the finish coating resists UV and retains its pigmentation and/or shield of UV filters on the surface of the epoxy barrier coat. A high gloss finish reflects a higher proportion of the light from the surface than a dull finish. Therefore, a white - especially a high gloss white - coating is much more durable.

Coating Compatibility

Most types of coatings are compatible with cured epoxy which is an almost completely inert, hard plastic. Thus, most paint solvents will not soften, swell or react with an epoxy surface. However, it is advisable to build a test panel to assure coating compatibility. **It is always recommended to check manufacturer's instructions to verify compatibility and suitability.**

One-part polyurethanes and polyester gelcoat can be affected by epoxy amines and if used must be applied when the epoxy is thoroughly cured, generally after two weeks at room temperature. A thorough cure can be achieved much quicker with elevated temperature post curing. Post curing will also improve epoxy's thermal properties and is recommended if dark paint is to be applied over epoxy.

Coating types

Latex paints are compatible with epoxy and they do an adequate job of protecting the epoxy barrier from UV radiation. In many architectural applications latex paint may be the most suitable coating to use. Their durability is limited.

Alkyd finishes - enamel, alkyd enamel, marine enamel, acrylic enamel, alkyd modified epoxy, traditional varnish and spar varnish - offer ease of application, low cost, low toxicity, and easy availability. Their disadvantages are low UV resistance and low abrasion resistance.

One-part polyurethanes offer easy application, cleanup and better properties than alkyds. They are also more expensive and some may be incompatible with amine cured epoxy systems such as WEST SYSTEM epoxy, although 207 Hardener offers good compatibility. Test first.

Two-part linear polyurethane (LP) paints offer the most durable protection available. LP's are available as pigmented or clear coatings and offer excellent UV protection, gloss retention, abrasion resistance and complete compatibility with epoxy. However, compared to other types of coatings, they are expensive, require more skill to apply and present a greater health hazard, especially when sprayed.

Epoxy paints are available in one-part and two-part versions. Two-part epoxies offer many characteristics similar to the higher performance polyurethanes. They are durable and chemically resistant, but offer limited UV protection compared to the linear polyurethanes.

Antifouling paints are available in a variety of formulations. Most antifouling paint systems are compatible with epoxy and can be applied directly over a prepared epoxy barrier coat. If unsure of compatibility or having curing or adhesion problems with a specific paint, use the primer recommended for that antifouling paint over the barrier coat. Follow the recommendations given for preparation of GRP surfaces. Other paints, including marine LP's and primers, are not recommended for use below the waterline.

Primers are usually not needed to bond a paint film to epoxy, although interfacing primers may be required with some specialised bottom paints and high-build primers are useful for hiding scratches or flaws in the substrate. If the instructions on the selected paint or varnish recommend a specially primed surface, follow the recommendations given for fibreglass preparation. Self-etching primers are not effective on an epoxy coating because of the chemical resistance of the epoxy.

Polyester gelcoat is a pigmented version of polyester resin used to build GRP boats and many other products. Gelcoat provides a smooth pre-finished surface and is applied during the production process of the boat or component part. It is not often used as a post-production finish coating, but it can be applied over epoxy and is useful in some repair situations. Unreacted epoxy will interfere with gelcoat cure. Refer to 002-550 Fibreglass Boat Repair & Maintenance, published by Wessex Resins, for detailed information on patching gelcoat over an epoxy repair.

Always follow the instructions from the manufacturer of the coating systems. Nevertheless, as previously stated, it is recommended to make a test panel to evaluate the degree of surface preparation required and the compatibility and handling characteristics of the finish system.

4. COLD TEMPERATURE BONDING

Epoxy can be used under cold weather conditions, but special application techniques should be employed to achieve acceptable long-term epoxy performance. These precautions are not elaborate or difficult and do not apply to WEST SYSTEM epoxy alone - any epoxy used at low temperatures may have its capabilities and performance affected which could promote significant problems if the epoxy is used in critical marine structural situations. In fact, due to differences in formulation, not all epoxies possess the necessary characteristics to perform well when used under cold weather conditions. The precautions are not elaborate or difficult.

4.1 Chemical characteristics

When an epoxy resin and hardener are mixed together, a chemical reaction is started which produces heat - an "exothermic reaction". The ambient temperature in which an epoxy chemical reaction takes place affects the rate or speed of this reaction. Warmer temperatures accelerate, while cooler temperatures retard the reaction time.

If the reaction is too slow, even though the epoxy may harden, it may not cure completely and possibly never achieve its designed physical properties. This is where danger lies, for improperly cured epoxy may possess enough strength to hold a structure together, yet may fail after repeated loadings during normal operation.

4.2 Working properties

Temperature has a profound effect on the working properties of uncured epoxy. Ambient temperature changes will dramatically change the viscosity (thickness) of the epoxy. When cold, the viscosity of water varies little with temperature changes until it freezes but temperature can have an effect that is 10 times greater on epoxy molecules than on water molecules over a temperature change of 15°C. Because of this, the colder it is, the thicker the epoxy becomes, significantly reducing its flow properties. This change has three important consequences for working with epoxy under cold conditions.

a.) It is more difficult to mix the resin and hardener thoroughly. The resin flows through the dispensing pumps and out of containers with much greater difficulty and both resin and hardener are prone to clinging to the surfaces of the pumps, containers and mixing tools. Remember, because of the low temperature, the chemical reaction is much slower and compounding a less efficient exothermic reaction with the potential for incomplete and/or inaccurate mixing, is a recipe for a permanently deficient bond.

b.) The mixed epoxy is much harder to apply because the viscosity is similar to cold honey and is extremely difficult to coat and wet out surfaces.

c.) Air bubbles may be introduced when mixing and remain in suspension due to the increased surface tension of the cold epoxy. This can be especially troublesome in clear-finish applications and osmosis repair work.

4.3 Cold weather techniques

Having explained that cold weather epoxy usage is both difficult and potentially dangerous, with a little advance planning and taking certain simple precautions, the problems detailed above can be addressed and their consequences avoided. The following six basic cold weather rules have been used for over 25 years and we have yet to experience a cold weather curing problem with WEST SYSTEM epoxy.

1. Use WEST SYSTEM 205 Fast Hardener.

WEST SYSTEM 205 Hardener has been designed with a chemically-activated polyamine system which exhibits a good cure at temperatures as low as 5°C. It exhibits a fast cure characteristic and offers less uncured exposure time thereby reducing the chances of incomplete cure due to cold temperatures.

2. Dispense resin and hardener in the proper mixing ratio.

All epoxies are formulated to a specific mix ratio of resin to hardener. It is important to mix epoxy in the precise ratio recommended by the manufacturer. Increasing the amount of hardener will not accelerate cure but it will seriously compromise the ultimate strength of the cured epoxy. **NOTE:** WEST SYSTEM Mini Pumps are designed and calibrated to dispense the correct ratio with one pump stroke of resin for every one pump stroke of hardener.

3. Warm resin and hardener before using.

As discussed above, the warmer the resin and hardener, the lower the viscosity. Thinner (lower viscosity) resin and hardener will flow through dispensing pumps better, cling less to containers and mixing equipment and exhibit superior handling and wet-out characteristics.

The two epoxy components can be warmed using heat lamps or kept in a warm area until they are needed. Another simple method of warming the resin and hardener is to construct a small hot box out of rigid sheets of foil-backed insulation. Place a regular light bulb or an electric heating pad inside to maintain a temperature no greater than 30°C.

4. Stir the resin and hardener thoroughly.

Use extra care when mixing the resin and hardener and mix for a longer period of time than normal. Scrape the sides and bottom of the mixing container using a mixing stick to reach the edges. Using a smaller diameter mixing pot will also improve the chemical activity because the limited surface area will contain the heat produced by the reaction.

5. Warm working surfaces.

Applying warmed epoxy to a cold structure will quickly retard the molecular bonding activity of the epoxy. Ensure the structure and the surrounding area is brought up to temperature. A hull, for example, which is colder than the surrounding air may

exhibit condensation and this moisture could contaminate the epoxy when it is applied. Warm the structure as much as possible. This can be done by constructing tents around small areas and heating with portable heaters or warming the area with hot air guns or heat lamps. Small components or materials e.g. glass cloth, can be warmed before use in a hot box as described in Paragraph 3 above.

6. Prepare surfaces carefully between applications.

When coating under cold conditions, a thin film of epoxy does not generate much heat. The rate or speed of cure is therefore extended and some reaction with moisture in the atmosphere may occur, resulting in the formation of an amine blush on the cured surface. Immediately prior to applying subsequent coatings, wash the surface with clean water, allow it to dry thoroughly and sand.

4.4 Cold weather storage

WEST SYSTEM materials should be stored above 10°C with the container caps screwed down tightly. Storing epoxy resin in extreme cold may cause crystallization but the formation of crystals does not compromise the resin and the situation can be remedied. Heat water in a pot large enough to hold the epoxy resin container. Remove the lid of the resin container to avoid pressure build-up and place the container in the hot water. Be careful to ensure no water enters the resin container. Stir the epoxy with a clean stick until the liquid regains clarity and all crystals have melted. Remove from the water, replace the lid tightly and invert the container to melt any crystals which may be clinging to the top of the container. If the resin pump has crystallized, pumping warm resin through should dissolve the crystals.

To keep WEST SYSTEM epoxy at a constant temperature construct a HOT BOX, as shown below.

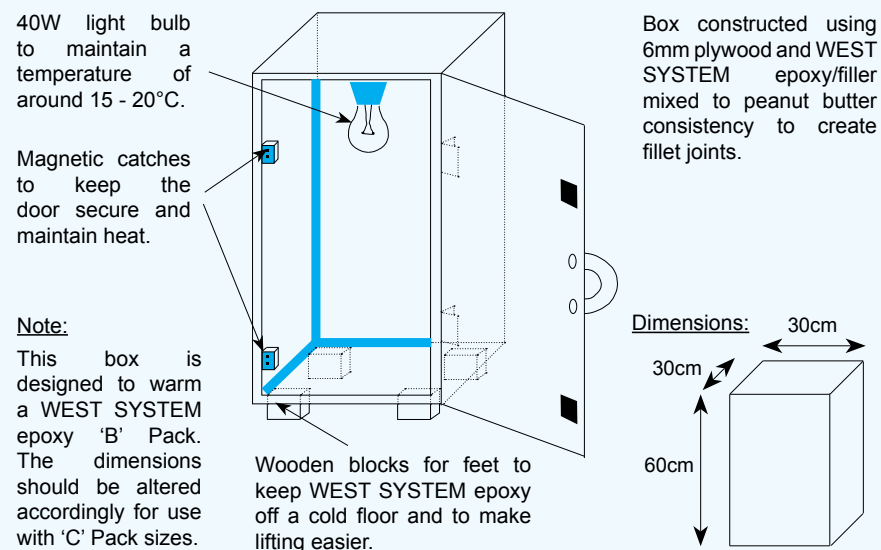

5. PRODUCT SELECTION AND ESTIMATING GUIDES

Hardener Selection Guide

Select a hardener for its intended use and for the cure speed best suited for your job in the temperature range in which you are working

Hardener	Resin/Hardener Use	Hardener Temperature Range (°C)						Cure Speeds at room temperature*			Mini Pump Required
		5°	10°	15°	20°	25°	30°	35°	Room Temp at (25°C) (60g mass) mins	Open Time at (21°C) (Thin film) mins	
205	Fast cure—General bonding, fabric application and barrier coating							10-15 mins	60-70 mins	5-7 hours	301 A,B or C
206	Slow cure—General bonding, fabric application and barrier coating							20-30 min	90-110 mins	9-12 hours	301 A,B or C
207	Special coating—Fabric application and coating for a natural wood finish							20-30 mins	85-110 mins	9-12 hours	303 A,B or C
209	Extra Slow cure—General bonding, fabric application, barrier coating							50-70 mins	200-260 mins	20-24 hours	303 A,B or C

*Note: Epoxy cures faster in warmer temperatures and in thicker applications. Epoxy cures slower in cooler temperatures and in thinner applications.

Filler Selection Guide

Uses Applications - desired characteristics Thickness of Resin/Hardener/Filler mixes.	Adhesive Fillers					Fairing Fillers			
	High density High strength					Lowest density Easiest sanding			
	404	406	403	402	405	407	409	410	
Small Glassfibre repairs (Peanut Butter Consistency)				****					
Bonding Hardware (Mayonnaise Consistency) - Increased fastener interface and hardware load capability - maximum strength	****	***	***		**				
General Bonding (Mayonnaise Consistency) - Join parts with epoxy thickened to create a structural gap filler - strength/gap filling	***	***	***		**	*			
Bonding with Fillets (Peanut Butter Consistency) - Increase joint bonding area and create a structural brace between parts - smoothness/strength	**	****	**		***	***			
Laminating (Ketchup Consistency) - bond layers of wood strips, veneers, planks, sheets and cores - gap filling strength	**	***	****		**	**			
Fairing (Peanut Butter Consistency) - Fill low areas and voids with an easily shaped and sanded surface filler/fairing compound - sandability/gap filling						***	****	****	

Filler suitability for various uses: **** = excellent, *** = very good, ** = good, * = fair, (no stars) = not recommended.

Selecting Fillers

As a rule, use higher-density fillers when bonding higher-density materials such as hardwoods and metals. Any of the adhesive fillers are suitable for most bonding situations. The choice of a filler for general use may be based on the handling characteristics preferred. Fillers may also be blended to create mixtures

Filler Characteristics Guide

GENERAL CHARACTERISTICS	FILLER							
	402	403	404	405	406	407	409	410
Mixing (Easiest = 5)	3	5	2	4	3	2	2	4
Texture (Smoothest = 5)	1	1	2	3	5	4	4	4
Strength (Strongest = 5)	4	4	5	4	4	2	2	1
Weight (Lightest = 5)	2	3	1	3	3	4	4	5
Sanding (Easiest = 5)	2	2	1	2	2	4	4	5

Filler suitability for various uses: 5 = excellent, 4 = very good, 3 = good, 2 = fair, 1 = poor

Filler Estimation Guide

FILLER	GENERAL CHARACTERISTICS		
	KETCHUP	MAYONNAISE	PEANUT BUTTER
402 Milled Glass Fibre Blend	N/A	N/A	25-30%
403 Microfibres	4%	7%	16%
404 High-Density Filler	35%	45%	60%
405 Filleting Blend	15%	20%	25%
406 Colloidal Silica	3%	5%	8%
407 Low-Density Filler	20%	30%	35-40%
409 Microsphere Blend	11%	16%	25-30%
410 Microlight	7%	13%	16%

The table above shows approximate percentages by weight of filler required to be added to mixed epoxy to product a 'Ketchup', 'Mayonnaise' or 'Peanut Butter' consistency for the various filler products.

Estimating coating coverage of Mixed WEST SYSTEM Epoxy

1.0 Kg of Mixed Epoxy	Saturation Coat over a Porous Surface at 25°C	Build-up Coat over a Non-Porous Surface at 25°C	Adding fillers or wetting out fabrics will decrease these coverages
105 Resin with 205 or 206 Hardener	6.5 - 7.5m ²	8.5 - 9.5m ²	
105 Resin with 207 or 209 Hardener	7.0 - 8.0m ²	9.0 - 10.0m ²	

The table gives the approximate quantity of mixed epoxy required to coat a 1m² area.

Please note the epoxy fairing mixes will provide an epoxy/filler thickness of approximately 3mm.

Epoxy Mix	Mixed Weight required to coat 1m ² at room temperature
105 Resin with 205 or 206 Hardener	135g
105 Resin with 207 or 209 Hardener	125g
105 Resin with 205 Hardener and 40% by weight of 407 Low-Density	1.8kg = 3mm Thick Layer
105 Resin with 205 Hardener and 16% by weight of 410 Microlight	1.5kg = 3mm Thick Layer

6. PROBLEM SOLVER

PROBLEM	POSSIBLE CAUSES	SOLUTION
The epoxy mixture has not cured after the recommended cure time has passed.	Off ratio – too much or too little hardener will affect the cure time and thoroughness of the cure.	<ol style="list-style-type: none"> 1. Remove epoxy. Do not apply additional material over non-curing epoxy. See removing epoxy on page 11. 2. Check correct number of pump strokes used - equal stroke of resin and hardener. DO NOT add extra hardener for faster cure! 3. Check for correct pump (5:1 or 3:1 ratio) and pump group size <u>e.g.</u> Group A 4. Check pump ratio (see pump instructions). See Dispensing on page 7.
	Low temperature-epoxy mixtures cure slower at low temperatures.	<ol style="list-style-type: none"> 1. Allow extra curing time in cool weather. 2. Apply heat to maintain the chemical reaction and speed the cure. NOTE! Unvented kerosene or propane heaters can inhibit the cure of epoxy and contaminate epoxy surfaces. 3. Use a faster hardener, designed to cure at lower temperatures. See understanding cure time & cold temperature bonding on pages 4 and 31.
	Insufficient mixing	<ol style="list-style-type: none"> 1. Remove epoxy. Do not apply additional material over non-curing epoxy. See epoxy removal note on page 11. 2. Mix resin and hardener together thoroughly to avoid resin rich and hardener rich areas. 3. Add fillers or additives <i>after</i> resin and hardener have been thoroughly mixed. See Mixing on page 8.
	Incorrect products	<ol style="list-style-type: none"> 1. Remove epoxy. Do not apply additional material over non-curing epoxy. See epoxy removal note on page 11. 2. Check for correct resin and hardener. Resin will not cure properly with other brands of hardeners or with polyester catalysts.
Bond Failure	Insufficient cure	See above
	Resin starved joint-epoxy has wicked into porous surfaces leaving a void at the joint.	Wet out bonding surfaces before applying thickened epoxy. Re-wet very porous surfaces and end grain. See Two-step bonding on page 14 .
	Contaminated bonding surface.	Clean and sand the surface following the preparation procedure on page 10 . Sand wood surfaces after planing or joining.
	Bonding area too small for the load on the joint.	Increase bonding area by adding fillets, bonded fasteners or scarf joints.
	Too much clamping pressure squeezed epoxy out of the joint.	Use just enough clamping pressure to squeeze a small amount of epoxy from the joint. See clamping note on page 20 .

PROBLEM	POSSIBLE CAUSES	SOLUTION
Clear Coating turned cloudy.	Moisture from condensation or very humid conditions reacts with components in uncured hardener.	<ol style="list-style-type: none"> 1. Apply moderate heat to partially cured coating to remove moisture and complete cure. Caution - avoid out gassing - See page 6. 2. Use 207 Hardener for clear coating applications and for bonding thin veneers where epoxy may bleed through to the surface.
	Entrapped air from aggressive roller application.	<ol style="list-style-type: none"> 1. Apply coating at warmer temperature-epoxy is thinner at warmer temperatures. 2. Apply epoxy in thin even coats. 3. Apply moderate heat to release trapped air and complete cure. Caution - avoid out gassing - See page 6.
Waxy film appears on surface of cured epoxy.	Amine blush forms as a result of the curing process.	Blush formation is typical. Remove with water. See special preparation- cured epoxy, on page 11 .
Runs or sags in coating.	Epoxy applied is too thick.	<ol style="list-style-type: none"> 1. Use 790 or 800 Roller Covers and roll the coating into a thinner film. A thin film will flow out much more smoothly than a thicker film after it is tipped off with the foam roller brush. 2. Warm the epoxy to reduce viscosity or apply the coating at a warmer temperature. See Cold Temperature Bonding on page 31.
	Coating curing too slowly.	<ol style="list-style-type: none"> 1. Apply the coating at a warmer temperature. 2. Warm the resin and hardener before mixing to speed the cure in cool weather. 3. Switch to a faster hardener if possible. See controlling cure time on page 5.
Fairing compound (using filler/407 or 410 mixture) sags and is difficult to sand.	Fairing material not thick enough.	<ol style="list-style-type: none"> 1. Add more filler to the mix until it reaches a "peanut butter" consistency - the more filler added, the stiffer it becomes and the easier it will be to sand. 2. Allow the wet-out coat to gel before applying the fairing material to vertical surfaces. See Fairing on page 21.
Paint, varnish or gelcoat will not cure over epoxy.	Epoxy not completely cured.	Allow the final epoxy coat to cure thoroughly. Allow several days if necessary for slow hardeners at cooler temperatures. Apply moderate heat to complete the cure if necessary. See controlling cure time on page 5 .
	Paint incompatible with epoxy.	<ol style="list-style-type: none"> 1. Use a different type of paint. Some paints and varnishes may be incompatible with some hardeners. If unsure, test for compatibility on a coated piece of scrap material. 2. Use 207 Hardener. It is compatible with most paints and varnishes.
	Epoxy surface not thoroughly prepared.	Remove the amine blush and sand the surface thoroughly before applying paints and varnishes. See Final surface preparation on page 28 .

PROBLEM	POSSIBLE CAUSES	SOLUTION
Epoxy became very hot and cured too quickly.	Batch too large, or left in mixing pot too long.	1. Mix smaller batches. 2. Transfer the mix to a container with more surface area, immediately after mixing. See Understanding cure time on page 4 . Dispensing and mixing on page 7 .
	Temperature too warm for the hardener.	Use 206 Slow or 209 Extra Slow Hardener in very warm weather.
	Application too thick.	When filling large, deep areas, apply mix in several thin layers.
Bubbles formed in coating over porous material (bare wood or foam)	Air trapped in the material escapes through coating (out-gassing) as the temperature of the material rises	1. Coat the wood as its temperature is dropping-after warming the wood with heaters or during the later part of the day. 2. Apply a thinner coat, allowing air to escape more easily. 3. Tip off the coating with a roller cover brush to break bubbles. See out-gassing caution on page 6 .
Pinholes appear in epoxy coating over abraded fibreglass or epoxy.	Surface tension causes epoxy film to pull away from pinhole before it gels.	After applying epoxy with 800 Roller Cover, force epoxy into pinholes with a stiff plastic or metal spreader held at a low or nearly flat angle. Re-coat and tip off coating after all pinholes are filled.
Fish-eyeing in coating.	Contamination of the coating caused by dirty application tools and/or inadequate preparation of the surface.	1. Ensure mixing equipment is clean. Avoid waxed mixing containers. 2. Ensure surface is properly prepared. Use correct grit paper for the coating, e.g. 80-grit for epoxy. See paint or varnish manufacturer's instructions for precise surface preparation.
		After surface is prepared, avoid contamination-fingerprints, exhaust fumes, rags with fabric softener (silicone). Coat within hours of preparation. After wet sanding, rinse water should sheet without beading (beading indicates contamination). If rinse water forms droplets/beads, clean and dry and repeat operation – see Final surface preparation, on page 28 .
Hardener has turned red after several years of storage.	Moisture in contact with hardener and metal container.	Red colour is a normal condition. It will not affect epoxy handling or cured strength. Avoid using hardener for clear coating or exposed areas where colour is not desired
Contact Wessex Resin & Adhesives or your local distributor for further technical help.		

7. THE PRODUCTS

WEST SYSTEM brand epoxy cures to a high-strength plastic solid at room temperature by mixing specific proportions of liquid epoxy resin and hardener.

By using a simple 'cookbook' approach it is possible to tailor the handling characteristics and the physical properties of the cured epoxy to suit the working conditions and specific application of the project in hand.

1. Begin with 105 Epoxy Resin, the basic ingredient of all WEST SYSTEM epoxy compounds
2. Control the cure time or adjust to working temperature or working time required with one of four specially formulated WEST SYSTEM hardeners
3. Select the correct set of MINI PUMPS

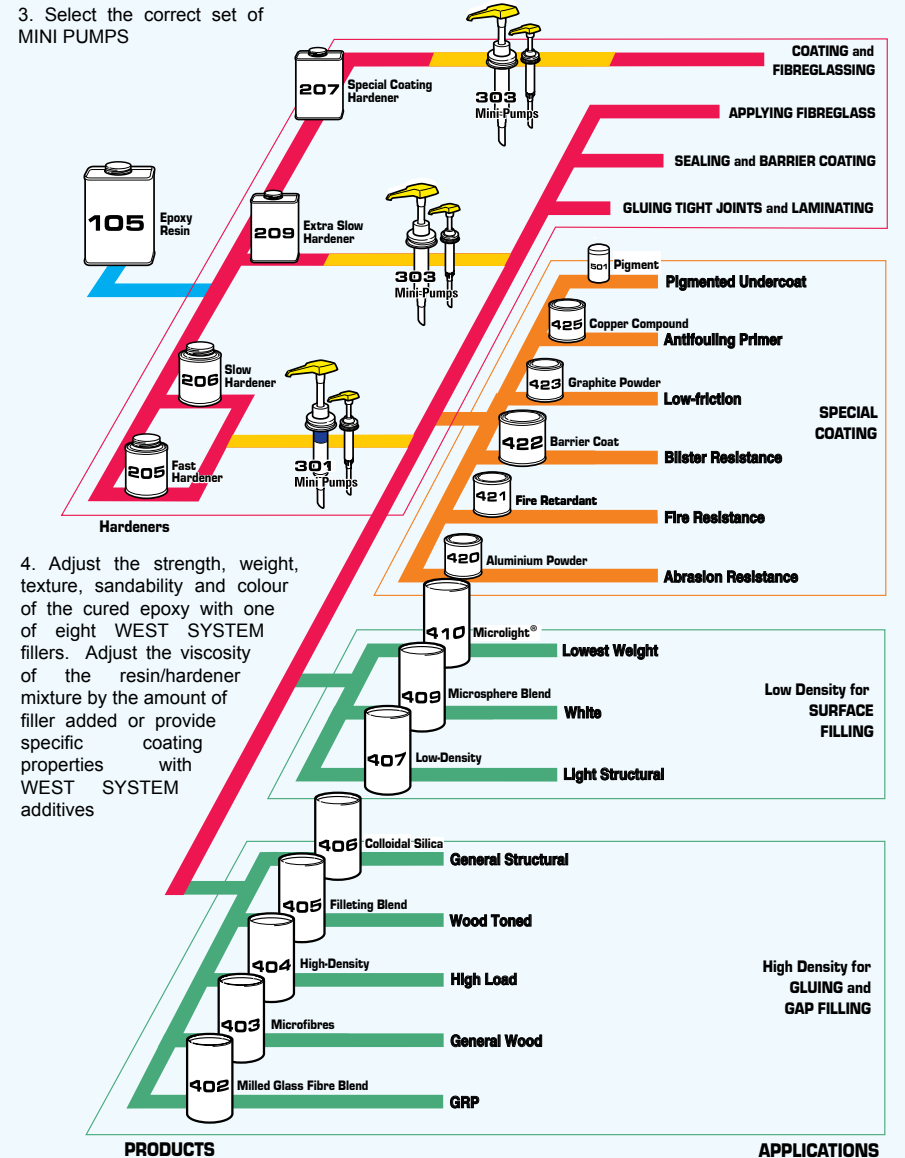

8. PRODUCT GUIDE

8.1 WEST SYSTEM RESIN & HARDENERS



105 Epoxy Resin®

105 Resin is a clear, low-viscosity liquid epoxy resin. Formulated for use with one of four WEST SYSTEM hardeners, it can be cured in a wide temperature range to form a high-strength solid with excellent moisture resistance.

105 Epoxy Resin, when mixed at the proper ratio with a WEST SYSTEM hardener, is an excellent adhesive. It is designed specifically to wet out and bond to wood fibre, fibreglass, reinforcing fabrics, foam other composite materials, and a variety of metals.

A superb adhesive, WEST SYSTEM epoxy will fill gaps and bridge voids when modified with WEST SYSTEM fillers and can be sanded and shaped afterwards. With roller application, it possesses excellent thin-film characteristics by flowing out and self-leveling without fisheyeing. Multiple coats of a 105 epoxy create a superior moisture barrier and a tough, stable base for paints and varnishes. The 105 Resin has a relatively high flash point, which makes it safer to work with than polyesters and is free from solvent odours and vapours. For each container size of resin, there is a corresponding sized container of hardener and mini pump size. When purchasing resin, hardener and mini pumps ensure that all items are labelled with the same pack size letter (i.e., A, B, C or E).

205 Fast Hardener®

205 Hardener is used in a majority of situations to produce a rapid cure and results in an epoxy which develops its physical properties quickly. When mixed in the ratio of five parts by weight of 105 Resin to one part by weight of 205 Hardener, the cured resin/hardener mixture yields a high-strength, rigid solid which has excellent cohesive properties and provides an outstanding moisture vapour barrier with excellent bonding and coating properties.

Pot Life at 25°C	10 to 15 minutes
Cure to Solid State at 21°C	5 to 7 hours
Cure to Maximum Strength at 21°C	5 to 7 days
Minimum Recommended Working Temperature	5°C
Pumps Required	(5:1 ratio) 301, 306-25, 309

206 Slow Hardener®

When this low viscosity curing agent is combined with 105 Resin in the ratio of five parts by weight of resin to one part by weight of 206 Hardener, the cured resin/hardener mixture yields a high-strength, rigid, moisture-resistant solid, excellent for use as a coating and bonding adhesive. Can be used for extended assembly times when working in ideal conditions.

Pot Life at 25°C	20 to 30 minutes
Cure to Solid State at 21°C	9 to 12 hours
Cure to Maximum Strength at 21°C	5 to 7 days
Minimum Recommended Working Temperature	16°C
Pumps Required	(5:1 ratio) 301, 306-25, 309

207 Special Coating Hardener™

207 Special Coating Hardener is formulated for use with WEST SYSTEM 105 Resin for coating applications where an extremely clear finish is desired. This hardener also provides excellent adhesion for bonding applications. 207 contains an ultraviolet inhibitor to protect the 105/207 mix against sunlight. However, the cured epoxy surface still requires long-term UV protection with a quality marine paint or a UV filtered two part varnish. **Note: Ratio 3:1 Resin:Hardener by volume.**

Pot Life at 25°C	20 to 30 minutes
Cure to Solid State at 21°C	9 to 12 hours
Cure to Maximum Strength at 21°C	5 to 7 days
Minimum Recommended Working Temperature	16°C
Pumps Required	(3:1 ratio) 303, 306-23, 309-3

209 Extra Slow Hardener™

209 Extra Slow Hardener is formulated for use with 105 Resin in extremely warm and/or humid conditions for general bonding and coating applications or when extended working time is desired at room temperature.

A 105/209 mix provides approximately twice the pot life and working time of 206 Slow Hardener and adequate pot life up to 43°C. Forms a clear amber coloured solid with good physical properties and moisture resistance for bonding and coating applications. **Note: Ratio 3:1 Resin:Hardener by volume.**

Pot Life at 25°C	50 to 70 minutes
Pot Life at 35°C	20 to 30 minutes
Cure to Solid State at 21°C	20 to 24 hours
Cure to Solid State at 35°C	6 to 8 hours
Cure to Maximum Strength at 21°C	5 to 9 days
Minimum Recommended Working Temperature	18°C
Pumps Required	(3:1 ratio) 303, 306-3, 309-3

8.2 EPOXY DISPENSERS

301 Mini Pumps

Designed for convenient and accurate dispensing of WEST SYSTEM 105 Resin and 205 or 206 Hardeners. Mini pumps ensure accurate metering of the resin/hardener mix and eliminate the mess involved with hand proportioning. The pumps mount directly onto the resin and hardener containers and have been calibrated to deliver the correct working ratio of 5 parts by weight of resin to 1 part by weight of hardener with one stroke from each pump. When the resin and hardener are in continual use, the pumps can be left mounted on the containers. Order 301A Mini Pumps for 'A' Pack containers, 301B Mini Pumps for 'B' packs or 301C for 'C' Packs.



Warning: do not use with 207 or 209 hardeners.

303 Special Ratio Mini Pumps

Designed for use with WEST SYSTEM 207 and 209 Special Application Hardeners. The mini pumps mount directly onto the resin and hardener containers and have been calibrated to deliver the correct working ratio of 3.5 parts by weight of resin to 1 part by weight of hardener with one stroke from each pump. See *Dispensing with Mini Pumps - page 7*.

Warning: do not use with 205 or 206 hardeners

306-25 Metering Pump

For metering larger quantities of 105 Resin and 205 or 206 (5:1 ratio) Hardeners. The 306-25 Pump will reduce mixing time and waste on large projects. A

carrying handle allows you to move the pump where the work is. Reservoirs hold approximately 3.75 litres of resin, 900ml of hardener. Dispenses approximately 15g of resin/hardener per pump stroke (500g per minute). Can be converted to a 3:1 ratio.

306-23 Metering Pump

Similar to 306-25 Metering Pump described above. For metering 105 Resin and 207 Special Coating or 209 Extra Slow (3:1 ratio) Hardeners. Can be converted to 5:1 ratio.

306-K235 Rebuild Kit

For 306-25 (5:1) ratio and 306-23 (3:1) ratio pumps. Includes seals, balls, gaskets, springs, high-rise tubes with ferrules and new resin and hardener reservoirs with lids.

306-K and 306-3K Rebuild Kits: for older model 306 (single body) dispensing pumps.

309 High-Capacity Gear Pump

Designed and built by Gougeon Brothers. The home builder and professional alike will enjoy the efficiency of this pump. The resin/hardener mix is delivered with continuous rotation of the crank. Dispenses approximately 500g per minute, yet can dispense smaller quantities with partial crank rotation. A positive shut-off valve eliminates resin and hardener loss and dripping spouts. The convenient handle makes it easy to carry the pump to right where it's needed. Stainless steel reservoirs hold 10kg of resin, 5kg of hardener. Also available in 309-3 Special ratio configuration for use with 207 or 209 Hardeners.

309-3 High-Capacity Gear Pump

Similar to 309 High-Capacity Gear Pump described above. For metering 105 Resin and 207 Special Coating or 209 Extra Slow (3:1 ratio) Hardeners.



8.3 REPAIR PACKS AND RESIN PACKS

101 Mini Pack

Contains a selected mix of materials used to complete smaller repairs around the boat, in the workshop or at home. Contents include: 250g 105 Resin, 50g 205 Hardener, 403 & 407 fillers, dispensing syringes, application tools, gloves and instructions.

104 Junior Pack

A 600g pack of WEST SYSTEM epoxy (105/205). Designed for the small users.

105-K Glass fibre Boat Repair Kit

This kit includes all the materials required to complete a range of repairs to glass fibre boats. Contents: 250gm 105 resin, 50gm 205 hardener, 402 milled glass, 409 microspheres blend, Three mixing cups, One Reusable mixing stick, Two pairs nitrile gloves, Two glue brushes, Two syringes, 1m x 125mm 450g/m² biaxial glass tape, 1m x 75mm 175g/m² plain weave glass tape, 1m x100mm peel ply, Instructions.

8.4 SPECIALTY EPOXIES



G/flex® Epoxies

G/flex Epoxy is a toughened, resilient two-part epoxy engineered for a superior grip to metals, plastics, glass, masonry, fibreglass, and wet and difficult-to-bond woods. Make structural bonds that absorb the stresses of expansion, contraction, shock and vibration. Easy-to-use 1:1 mix ratio provides a 45 minute pot life and a long open time of 75 minutes at room temperature. Reaches an initial cure in 3–4 hours and a workable cure in 7–10 hours.

Available in two consistencies.

650 Epoxy is a versatile easily-modified liquid epoxy.

655 Epoxy Adhesive is a convenient pre-thickened epoxy.

G/flex 650 Epoxy

650-8 118ml resin/118ml hardener. **650-32** 500ml resin/500ml hardener. Larger sizes are available.

650-K Kit contains 118ml G/flex 650 Resin, 118ml G/flex 650 Hardener, 2 reusable mixing stick/applicators, 2 12 cc syringes, 4g of adhesive filler, 4 mixing cups, 1 pair of disposable neoprene gloves, 4 alcohol cleaning pads and handling and repair instructions.

G/flex 655 Epoxy Adhesive

655-K Kit contains 125ml G/flex 655 Resin, 125ml G/flex 655 Hardener (250ml mixed epoxy), 2 reusable mixing stick/applicators, 4 alcohol cleaning pads, 1 pr disposable neoprene gloves, 10 mixing palettes and handling and repair instructions.

Six10® Epoxy Adhesive

A two-part thickened epoxy adhesive in a convenient, self-metering cartridge. For permanent, waterproof, structural gap-filling and gluing. Bonds to wood, fibreglass, metals and masonry. With the included 600 Static Mixer attached fully mixed adhesive can be dispensed right where it is needed using a standard caulking gun. Working time is 42 minutes at 21°C, cures to a solid in 5–6 hours and takes high loads in 24 hours. Contains 190 ml of resin and hardener.

Extra 600 Static Mixers are available.

G/5® Five-Minute Adhesive

An easy to use two part, fast setting resin/hardener system. This adhesive is ideal for quick repairs and general bonding around the boat and in the home, the workshop or garage. It is suited for spot applications to hold component parts in position whilst bonding is completed with WEST SYSTEM epoxy. G/5 will adhere to most prepared surfaces including wood, fibreglass and most metal and cures in 4-5 minutes.

8.5 WEST SYSTEM PACKS

WEST SYSTEM resins and hardeners are available in these pack sizes.

PACK SIZE	RESIN QUANTITY	HARDENER QUANTITY	MIXED QUANTITY
Junior	500g	100g	600g
A	1kg	200g	1.2kg
B	5kg	1kg	6kg
C	25kg	5kg	30kg
E	225kg	45kg	270kg

Storage/Shelf Life

Store at room temperature. Keep containers closed to prevent contamination. With proper storage, resin and hardeners will remain usable during the products shelf life. Over time, 105 Resin will thicken slightly and will therefore require extra care when mixing. Hardeners may darken with age, but physical properties are not affected by colour. Mini Pumps may be left in containers during storage. After a long storage, it is recommended to verify the metering accuracy of the pumps and mix a small test batch to assure proper curing. Repeated freeze/thaw cycles during storage may cause crystallization of 105 Resin. *See Cold weather storage - page 33*

8.6 FILLERS

ADHESIVE FILLERS

402 Milled Glass Fibre Blend

A high density blended filler consisting of loose chopped glass and other fillers, intended for small semi structural repairs, filling voids, or small scale impact damage to glass fibre laminates. The finished repairs are incredibly strong, tough and resilient. When mixed with WEST SYSTEM epoxy at a ratio of approximately 25% by weight, the result is a thick paste that can be carefully stippled into place with a brush and can be held in place with PVC tape or peel ply to give a smooth finish to the repair. Typical uses include deep void repair due to osmotic damage; damage to dinghy rudder and centre boards and hard edge impact damage on small sailboats.



403 Microfibres

A blend of cellulose cotton fibres, used as a thickening additive for bonding applications. Epoxy thickened with microfibres provides good wetting out of the substrate and excellent gap-filling properties. Add 4% to 16% by weight of 403 to WEST SYSTEM epoxy mix. Colour: off-white

404 High-Density Filler

A filler developed to maximise bond strength in hardware bonding where high cyclic loads are anticipated. It can also be used for filleting and gap-filling applications. May be added to the resin/hardener at a rate of 35% to 60% by weight, depending on the viscosity needed. Colour: off-white

405 Filleting Blend

Consists of a mix of cellulose fibres and other fillers for use in filleting applications when a naturally finished interior is intended. Alcohol or waterbased stains may be added to adjust the colour. Add 15% to 25% by weight to the epoxy mix. Colour: tan

406 Colloidal Silica

General purpose thickening additive suitable for bonding, gap-filling and filleting. It can be used to prevent resin flow on vertical and overhead surfaces and to control the viscosity of the epoxy. It is often used in combination with other fillers to control the working characteristics of an epoxy mix, e.g. improve the consistency of fairing compounds. Add 3% to 8% by weight to the resin/hardener mix. Colour: off-white.

FAIRING FILLERS

407 Low-Density Filler

A blended microballoon-based filler used to make fairing putties which are easy to sand but remain strong on a strength-to-weight basis. Add 20% to 40% by weight to mixed WEST SYSTEM epoxy. Cures to a dark reddish-brown colour.

409 Microsphere Blend

A pure white, hollow glass bubble based, low density filler designed for filling and fairing of fibreglass. When the filler is mixed with WEST SYSTEM epoxy at a ratio of 10% to 25% by weight, it creates a smooth creamy paste for filling and fairing over glass fibre repairs. The cured epoxy/filler is very easy to sand. Being white in colour the cured epoxy filler mix will be hidden easily behind paint or polyester gelcoat but must be protected by further coats of epoxy if used below the waterline.

410 Microlight®

410 Microlight™ is the ideal low-density filler for creating a lightweight, easily worked fairing compound especially suited for large areas. Microlight is easily blended into the epoxy mix at additions between 7% to 16% by weight and when cured is easier to sand than any other filled system. Holds a feather edge and is more cost effective than other fillers. Not recommended for high temperature applications and should not be coated with dark colours. Cures to a tan colour.

ADHESIVE FILLERS VS. FAIRING FILLERS

Fillers are used to thicken the basic resin/hardener mixture for specific applications. Each filler possesses a unique set of physical characteristics, but they can be generally categorized as either Adhesive (high-density) or Fairing (low-density).

Adhesive filler mixtures cure to a strong, hard-to-sand plastic useful in structural applications like bonding, filleting and hardware bonding.

Fairing filler mixtures cure to light, easily sandable material that is generally used for cosmetic or surface applications like shaping, filling or fairing. Seal all faired surfaces with epoxy before painting.

8.7 ADDITIVES

420 Aluminium Powder

Add between 5% to 10% by volume to provide protection from ultraviolet light in areas which will not be protected with other coatings and as a base for subsequent painting. Will substantially increase the hardness of the coated surface.

Additives for special coating properties

Additives are mixed with the epoxy to alter the physical properties when used as a coating. Additives can be used to alter the colour, abrasion resistance or moisture resistance of cured epoxy.

421 Fire Retardant

A fine white powder added to the epoxy in the ratio of one to one by weight. The cured material is a fire retardant composition for use in engine or galley areas. 421 Fire Retardant will greatly increase the viscosity of the epoxy and the composition requires trowelling or squeegeeing into place.

422 Barrier Coat Additive™

A proprietary blend designed to improve the moisture-exclusion effectiveness of WEST SYSTEM epoxy and to combat osmosis. It is an excellent additive for providing a barrier coating to overcome gelcoat blistering and also increases the abrasion resistance. Add 20% to 25% by weight of 422 to the mixed epoxy.

423 Graphite Powder

A fine black powder added to WEST SYSTEM epoxy (10% by volume) to produce a low-friction exterior coating with increased scuff resistance, durability and mar-resistance. Epoxy/graphite is commonly used as a coating on rudders and centreboards or on the bottoms of racing craft that are dry sailed. The epoxy/graphite mix can also be used in teak deck construction to simulate traditional seams in appearance and to protect the resin from sunlight.

425 Copper Compound

425 Copper Compound can be added to the mixed epoxy to provide a base coat for conventional antifouling paint. When added to epoxy at the rate of 80% by weight, the resultant hard surface increases the moisture exclusion effectiveness,

abrasion resistance and provides some backup antifouling properties. It is ideal for coating any substrate that will be in contact with water and can be used when a harder surface is required, eg., coating moulds.

501/506 Colour Pigments

Can be added to the epoxy to provide a base colour for a final finish system. The coloured surfaces also tend to highlight flaws and imperfections. Pigments should be added at a rate of approximately 3%-5% by weight and should only be added to the final coat of epoxy because the increased viscosity of the mix will impair the ability of the epoxy to penetrate and seal surfaces. Available in white (501), black (502), blue (505) and grey (506).

8.8 EPISIZE™ REINFORCING MATERIALS



Specifically treated with an amino-silane coupling agent for use with epoxy systems. When used with WEST SYSTEM epoxy, reinforcing materials exhibit significantly improved peel strength, flexural modulus and tensile and compressive load-carrying ability compared with other chemical finishing systems, especially those reinforcing materials manufactured for bonding with polyester resins.

All reinforcing materials sold under the Episize trademark are manufactured under strict quality control guidelines. Materials undergo periodic testing at Wessex Resins to ensure the materials selected for building or repair projects meet the highest possible standards.

740-746 Glass Fabrics

Episize™ Glass Fabrics are ideal for building composite laminates and for the repair of fibreglass structures. May also be used to provide an abrasion-resistant covering for wood structures. When thoroughly wetted with WEST SYSTEM epoxy, the lighter fabrics become transparent, allowing a clear, natural wood finish.

- 740 – 135g/m² Plain Weave Glass Cloth 1000mm wide
- 741 – 200g/m² Plain Weave Glass Cloth 1000mm wide
- 742 – 200g/m² Twill Weave Glass Cloth 1200mm wide
- 743 – 280g/m² Twill Weave Glass Cloth 1000mm wide
- 746 – 260g/m² Woven Roving 1250mm wide

All the above are available in 5m, 10m, 25m, 50m and 100m lengths

736-739 Biaxial Glass Fabrics

These non-crimp fabrics combine two layers of unidirectional fibres $\pm 45^\circ$ which are stitched together using a light thread. The result is an engineered biaxial fabric with predictable, repeatable properties.

- 736 – 300g/m² $\pm 45^\circ$ Biaxial Glass Fabric 1265mm wide
- 738 – 600g/m² $\pm 45^\circ$ Biaxial Glass Fabric 1250mm wide
- 739 – 450g/m² $\pm 45^\circ$ Biaxial Glass Fabric 1250mm wide

All the above are available in 5m, 10m 25m and 50m lengths

729-733 Glass Tape

Versatile glass tapes are ideal for reinforcing chines, hull-deck corners and similar structural applications. When bonded with WEST SYSTEM epoxy, they provide additional tensile strength to resist hairline crack development and provide added abrasion resistance. Weight 175g/m²

- 729A – 175g/m² Plain Weave Glass Tape 25mm wide 10m Length
- 729B – 175g/m² Plain Weave Glass Tape 25mm wide 50m Roll
- 730A – 175g/m² Plain Weave Glass Tape 50mm wide 10m Length
- 730B – 175g/m² Plain Weave Glass Tape 50mm wide 50m Roll
- 731A – 175g/m² Plain Weave Glass Tape 75mm wide 10m Length
- 731B – 175g/m² Plain Weave Glass Tape 75mm wide 50m Roll
- 732A – 175g/m² Plain Weave Glass Tape 100mm wide 10m Length
- 732B – 175g/m² Plain Weave Glass Tape 100mm wide 50m Roll
- 733A – 175g/m² Plain Weave Glass Tape 150mm wide 10m Length
- 733B – 175g/m² Plain Weave Glass Tape 150mm wide 50m Roll



727 Biaxial Glass Tape

Available in 125mm width, weight 450g/m² $\pm 45^\circ$. This tape significantly increases structural strength where major reinforcement is required.

- 727A – 450g/m² Biaxial Glass Tape 125mm wide 5m Length
- 727B – 450g/m² Biaxial Glass Tape 125mm wide 90m Roll

773-775 Peel Ply

Peel Ply is a finely woven fabric treated with a release agent to which epoxy will not bond. Excellent for providing a release and reducing subsequent sanding prior to applying more epoxy.

- 773 – 83g/m² Plain Weave Peel Ply 500mm wide 100m Roll

- 774 – 83g/m² Plain Weave Peel Ply 1000mm wide

Available in 5m, 10m, 25m, 50m and 100m lengths

- 775 – 83g/m² Plain Weave Peel Ply 1250mm wide

Available in 5m, 10m, 25m, 50m and 100m lengths

- 776-50 – 83g/m² Plain Weave Peel Ply Tape 50mm wide 100m Roll

- 776-100 – 83g/m² Plain Weave Peel Ply Tape 100mm wide 100m Roll

8.9 APPLICATION TOOLS



Tool reusability

Epoxy will not bond well to many plastic tools. This is because plastic has a glossy surface that does not provide enough texture, or tooth, for epoxy to key into. When cured, flex the tool to loosen epoxy. Thick films pop off easier than thin films. As a tool becomes scuffed and scratched from use, it will become more difficult to pop the cured epoxy from the surface.

790 180mm Foam Roller Cover

180mm wide, 45mm diameter, foam roller cover.

791 180mm Roller Frame

180mm wide bird cage roller frame designed for use with the 790 Roller cover.

800 75mm Foam Roller Cover

75mm wide foam roller cover - ideal for coating epoxy in small areas.

801 75mm Roller Frame

Reusable 75mm wide roller frames for use with the 800 roller covers.

802 Roller Pan

Flexible plastic roller pan allows cured epoxy to 'pop out', so the pan can be reused. Eliminates the need for liners.

803 Glue Application Brushes

Handy, disposable, glue brushes with a wooden handle. These brushes are used for a wide variety of gluing and coating applications.

804 Reusable Mixing Sticks

A practical mixing, application, filleting, and cleaning tool. Squared, beveled end reaches mixing pot corners for thorough mixing and blending in fillers and for cleaning up excess epoxy. Use rounded end to shape 10mm radius fillets. Cured epoxy pops off easily, so they can be reused many times.

804B Wooden Stirrers

300mm x 27mm, square edged wooden stirrers will ensure thorough mixing when high percentages of fillers are incorporated into the epoxy. Strong, durable stirrers that are ideal for scraping excess epoxy from surfaces.

805 Graduated Mixing Pot

Strong reusable 800ml mixing pots graduated in 50ml divisions. When cured, solid epoxy easily "pops out".

807 Syringes

Reusable syringes which can be loaded with the epoxy for injecting into difficult working areas. Ideal for hardware bonding and plywood repairs. 10ml and 50ml available.

808 Plastic Squeegees

Lightweight, reusable squeegees for fairing and filling applications. Double-edged, 90mm x 150mm.

809 Notched Spreaders

110mm x 110mm Lightweight, reusable spreaders with 3mm, 4mm and 6mm notches on three sides for quickly applying modified epoxy at a constant rate. Useful when laminating large panels

811 Paddle Rollers

Ridged aluminium rollers for thoroughly wetting-out fabrics with epoxy. Available in 50mm and 150mm lengths, diameter 22mm.

817 Finishing Brush

High quality brush for varnish or paint application. Available in 25mm and 50mm widths.

818 Laminating Brush

Good quality firm bristle brush for applying epoxy over the laminating area and for consolidating the fabric. Available in 50mm width.

820 Resin Removing Cream

Formulated to remove uncured epoxy from skin. Available in 250 dispensers and 1kg plastic pots.

831 Barrier Cream

An aerosol containing a non-irritant, multi-purpose barrier cream which has special bactericidal ingredients to minimise the risk of skin infection. Protects against resins, oils, grease and petroleum spirits.

832 Disposable Gloves

Lightweight, seamless disposable gloves help prevent exposure to chemicals. Excellent protection with good finger sensitivity and dexterity. CE marked.

834 Reusable Gloves

Heavy-duty rubber gloves offer superior tear and abrasion resistance and are liquid proof. Can be reused. CE marked.

850 Cleaning Solvent

A specially blended cleaning solvent for removing uncured epoxy from tools, boat and workshop surfaces. Also excellent for cleaning contaminants from cured epoxy surfaces.

855 Cleaning Solution

A safe, easy to use cleaning solution developed to remove uncured epoxy from tools workbenches, minipumps etc. Can also be used to wash off amine blush.



875 Scarffer®

A unique tool designed by Gougeon Brothers for cutting accurate scarf joints in plywood up to 9mm thick. Attaches easily to most circular saws and is simple to remove.

885 Vacuum Bagging Kit

A complete starter kit for room temperature repairs and small laminating projects up to 1.2m² in size. The kit includes: Venturi vacuum generator (with bronze muffler), Vacuum Cups (3), 6mm i/d. Vacuum Tubing (3m), Vacuum Gauge, Junction "T" Barbs (2), Release Fabric (1.4m²), Breather Fabric (1.4m²), Vacuum Bag Film (1.4m²), Vacuum Bag Sealant (7.5m), Instruction leaflet, 002-150 VACUUM BAGGING TECHNIQUES.



The venturi generator develops over 65kPa of vacuum (0.065MPa) and is designed to run off of conventional shop air compressors delivering at least 0.42MPa. Some item specifications may vary.

Harness the atmosphere

Vacuum Bagging is a clamping system used for laminating a wide range of fabrics, core materials and veneers. It uses atmospheric pressure to deliver firm, even clamping pressure over the entire surface area of a composite part or repair, regardless of the material or materials being laminated. By laminating over simple moulds, composites can be moulded into a wide range of functional shapes.

8.10 INSTRUCTIONAL PUBLICATIONS

002 The Gougeon Brothers on Boat Construction

This book is a must for anyone building a boat or working with wood and WEST SYSTEM epoxy. Includes extensive chapters on composite construction techniques, materials, lofting, safety and tools, with many illustrations, diagrams and photographs. Hardcover - 406 pages



002-550 Fibreglass Boat Repair & Maintenance

A complete guide to repair fibreglass boats with WEST SYSTEM epoxy. Includes illustrated procedures for structural reinforcement, deck and hull repair, hardware installation, keel repair and teak deck installation. Softcover 75 pages.

002-970 Wooden Boat Restoration & Repair

An illustrated guide to restore the structure, improve the appearance, reduce the maintenance and prolong the life of wooden boats with WEST SYSTEM epoxy. Includes information on dry rot repair, structural framework repair, hull and deck planking repair, hardware installation with epoxy and protective coating. Softcover 76 pages.

002-650 Gelcoat Blisters - A Guide to Osmosis Repair

A guide for repairing and preventing gelcoat blisters in fibreglass boats with WEST SYSTEM epoxy. Includes an analysis of the factors that contribute to blister formation and illustrated steps for preparation, drying, repairing and coating for moisture protection. Softcover 22 pages.

002-150 Vacuum Bagging Techniques

A step-by-step guide to vacuum bag laminating, a technique for clamping wood, core materials and synthetic composites bonded with WEST SYSTEM epoxy. Discusses theory, moulds, equipment and techniques used to build composite structures. Softcover 52 pages.

002-740 Final Fairing & Finishing

Techniques for fairing wood, fibreglass and metal surfaces. Includes fairing tools, materials and a general guide to finish coatings. Softcover 29 pages.

8.11 INSTRUCTIONAL VIDEOS

002-894 Fibreglass Repair with WEST SYSTEM Brand Epoxy

A guide to structural repair on fibreglass boats. Covers repairs to cored and non-cored panels and how to apply gelcoat over epoxy repairs. VHS—20 min.

002-896 Gelcoat Blister Repair with WEST SYSTEM Brand Epoxy

A guide for repairing and preventing gelcoat blisters on fibreglass boats. Includes an analysis of the factors contributing to blister formation and steps for preparation, drying, repairing and coating for moisture protection. VHS—16 min.

8.12 INSTRUCTIONAL DVD

002-898 WEST SYSTEM Epoxy How-To DVD

A compilation of three instructional videos demonstrating basic handling and advanced epoxy repair techniques.

Basic Application Techniques—A guide to the optimum use of WEST SYSTEM epoxy products, including epoxy safety and procedures for coating, bonding and fairing.

Fibreglass Repair with WEST SYSTEM Epoxy—Using WEST SYSTEM epoxy to make structural repairs on fibreglass boats, including repairs to cored and non-cored hulls and how to apply gelcoat over epoxy repairs.

Gelcoat Blister Repair with WEST SYSTEM Epoxy—A guide for repairing and preventing gelcoat blisters on fibreglass boats. Analyzing the causes of blister formation, preparing and drying fibreglass hulls, and repairing and coating for moisture protection with WEST SYSTEM epoxy.

Interactive menus allow for easy navigation through these subjects. DVD—59 minutes.

International Distributors of WEST SYSTEM Brand Products

CROATIA & SERBIA

Yacht Center Adriatic d.o.o.
Tel: +385 1 56 16 306
Email: info@yachtcenter.hr

DENMARK

H F Industri & Marine
Tel: +45 62 201312, Fax: +45 62 201477
Email: info@hfmarine.dk

EGYPT

MAPSO
Tel: +202 6984 777, Fax: +202 6990 780
Email: mapso@mapso.com

ESTONIA

Bang & Bonsomer Estonia
Tel: +372 6580000, Fax: +372 6580001
Email: office@bangbonsomer.ee

FINLAND

Bang & Bonsomer Oy
Tel: +358 9681081, Fax: +358 96924174
Email: reinforced.plastics@bangbonsomer.fi

FRANCE

AGL Marine
Tel: +33(0)493906011, Fax: +33(0)493477468
Email: aglmarine@agl-marine.com

GERMANY, AUSTRIA & SWITZERLAND

M.u.H. von der Linden GmbH
Tel: +49(0)281338300, Fax: +49(0)2813383030
Email: service@vonderlinden.de

GREECE

Delos Co Ltd
Tel: +30 22990-41056, Fax: +30 22990-41059
Email: info@delos.gr

HOLLAND, BELGIUM & LUXEMBOURG

Epifanes/W.Heeren & Zoon B.V.
Tel: +31 297 360366, Fax: +31 297 342078
Email: info@epifanes.nl

INDIA

Sailing Stuff
Tel: +91 9820033780, Fax: +91 (22) 22876355
Email: info@sailingstuff.in

ISRAEL

Atlantis Marine Ltd
Tel: +972 3 5227978, Fax: +972 50 269449
Email: atlantis@inter.net.il

ITALY

WS Marine S.r.L.
Tel: +393450062582
Email: info@wsmarine.it

LATVIA

Bang & Bonsomer UAB
Tel: +370 5 2622887, Fax: +370 5 261 7251
E-mail: office@bangbonsomer.lt

LEBANON

Bardawil & Co.
Tel: +96 11 894566, Fax: +96 11 884187
Email: bardawil@bardawil.com.lb

LITHUANIA

Bang & Bonsomer UAB.
Tel: +370 5 2622887, Fax: +370 5 2617251
Email: office@bangbonsomer.lt

MALTA

Dockshop Ltd
Tel: +356 21340566, Fax: +356 21340188
Email: info@dockshopmalta.com

NORWAY

WEST SYSTEM Norge A/S
Tel: +47 22233500, Fax: +47 22180604
Email: firmapost@westsystem.no

POLAND

CMS Co. Ltd.
Tel: +48 (91)4314300, Fax: +48 (91)4314300
Email: info@farbyjachtowe.pl

PORTUGAL

INMARTEC, LDA.
Tel: +351(256)758491, Fax: +351(256)751350
Email: fernando.santos@inmartec.pt

REPUBLIC OF IRELAND

Waller & Wickham
Tel: +353 1 8392330, Fax: +353 1 8392362
Email: info@wallerwickham.ie

ROMANIA

Nature Colours S.R.L.
Tel: +4 021 320 44 70, Fax: +4 021 320 17 75
Email: office@naturecolours.ro

SOUTH AFRICA

Harveys Composites
Tel: +27 11 230 5300, Fax: +27 11 397 8206
Email: mike.allen@harveyscomposites.co.za

SPAIN

Pinmar SL
Tel: +34 971 713744, Fax: +34 971 718143
Email: pinmar@pinmar.com
Barcelona Office:
Tel: 34 932 214454, Fax: 34 932 214160
Email: pinmar@pinmar.com

SWEDEN

HF Marin Sweden
Tel: +46 550 77 11 11
Email: info@hfmarinSweden.se

TURKEY

East Marine Denizcilik ve Turizm A.Ş.
Tel: +90 216 517 0863, Fax: +90 216 374 9532
Email: btaskent@westmarine.com.tr

UNITED ARAB EMIRATES

Marine & Elect. Supplies Co. LLC
Tel: +971 2 6734 900, Fax: +971 2 6730 070
Email: mescoauh@emirates.net.ae

UKRAINE

UA-Marine Ltd
Tel: +380(512)580540, Fax: +380(512)580540
Email: info@ua-marine.com.ua

WEST SYSTEM®

epoxy



WEST SYSTEM epoxy is manufactured in the UK under licence from Gougeon Brothers Inc., by:

Wessex Resins & Adhesives
Cupernham House, Cupernham Lane,
Romsey, Hampshire, SO51 7LF

Telephone:
Facsimile:

+44 (0) 1794 521111
+44 (0) 1794 521271

email:
Web Site:

information@wessex-resins.com
www.westsystem.co.uk
www.wessex-resins.com